

DS-2CD2387G2-LSU/SL

8 MP ColorVu Strobe Light and Audible Warning Fixed Turret Network Camera

ColorVu



Hikvision ColorVu technology provides 24/7 vivid colorful images with F1.0 advanced lenses and high performance sensors. F1.0 super-aperture collects more light to produce brighter images. Advanced sensor technology can vastly improve the utilization of available light.

- High quality imaging with 8 MP resolution
- Efficient H.265+ compression technology
- Clear imaging against strong backlight due to 130 dB WDR technology
- Focus on human and vehicle targets classification based on deep learning
- 24/7 colorful imaging
- Active strobe light and audio alarm to warn intruders off
- Provide real-time security via built-in two-way audio
- Audio and alarm interface available
- Water and dust resistant (IP67)

▪ Specification

| Camera | |
|-----------------------------|---|
| Image Sensor | 1/1.2" Progressive Scan CMOS |
| Max. Resolution | 3840 × 2160 |
| Shutter Speed | 1/3 s to 1/100,000 s |
| Min. Illumination | Color: 0.0005 Lux @ (F1.0, AGC ON), 0 Lux with white light |
| Day & Night | 24/7 Color imaging |
| Angle Adjustment | Pan: 0° to 360°, tilt: 0° to 75°, rotate: 0° to 360° |
| Lens | |
| Lens Type | Fixed focal lens, 2.8 and 4 mm optional |
| Focal Length & FOV | 2.8 mm, horizontal FOV 102°, vertical FOV 52°, diagonal FOV 124° 4 mm, horizontal FOV 88°, vertical FOV 47°, diagonal FOV 104° |
| Lens Mount | M mount |
| Iris Type | Fixed |
| Aperture | F1.0 |
| Depth of Field | 2.8 mm: 4 m to ∞ 4 mm: 6.2 m to ∞ |
| DORI | |
| DORI | 2.8 mm: D: 96 m, O: 38 m, R: 19 m, I: 9 m 4 mm: D: 102 m, O: 40 m, R: 20 m, I: 10 m |
| Illuminator | |
| Supplement Light Type | White Light |
| Supplement Light Range | Up to 30 m |
| Smart Supplement Light | Yes |
| Video | |
| Main Stream | 50 Hz: 25 fps (3840 × 2160, 3200 × 1800, 2688 × 1520, 1920 × 1080, 1280 × 720) 60 Hz: 24 fps (3840 × 2160) 30 fps (3200 × 1800, 2688 × 1520, 1920 × 1080, 1280 × 720) |
| Sub-Stream | 50 Hz: 25 fps (640 × 480, 640 × 360) 60 Hz: 30 fps (640 × 480, 640 × 360) |
| Third Stream | 50 Hz: 10 fps (1920 × 1080, 1280 × 720, 640 × 480, 640 × 360) 60 Hz: 10 fps (1920 × 1080, 1280 × 720, 640 × 480, 640 × 360) |
| Video Compression | Main stream: H.265/H.264/H.264+/H.265+ Sub-stream: H.265/H.264/MJPEG Third stream: H.265/H.264 |
| Video Bit Rate | 32 Kbps to 16 Mbps |
| H.264 Type | Baseline Profile/Main Profile/High Profile |
| H.265 Type | Main Profile |
| Bit Rate Control | CBR/VBR |
| Scalable Video Coding (SVC) | H.264 and H.265 encoding |
| Region of Interest (ROI) | 1 fixed region for main stream and sub-stream |
| Audio | |
| Environment Noise Filtering | -U: Yes |
| Audio Sampling Rate | -U: 8 kHz/16 kHz/32 kHz/44.1 kHz/48 kHz |

| | |
|--------------------------|--|
| Audio Compression | -U: G.711ulaw/G.711alaw/G.722.1/G.726/MP2L2/PCM/MP3/AAC |
| Audio Bit Rate | -U: 64 Kbps (G.711ulaw/G.711alaw)/16 Kbps (G.722.1)/16 Kbps (G.726)/32 to 192 Kbps (MP2L2)/8 to 320 Kbps (MP3)/16 to 64 Kbps (AAC) |
| Network | |
| Simultaneous Live View | Up to 6 channels |
| API | Open Network Video Interface (Profile S, Profile G, Profile T), ISAPI, SDK , ISUP |
| Protocols | TCP/IP, ICMP, HTTP, HTTPS, FTP, DHCP, DNS, DDNS, RTP, RTSP, NTP, UPnP, SMTP, IGMP, 802.1X, QoS, IPv4, IPv6, UDP, Bonjour, SSL/TLS, PPPoE, SNMP, WebSocket, WebSockets |
| User/Host | Up to 32 users. 3 user levels: administrator, operator and user |
| Security | Password protection, complicated password, HTTPS encryption, IP address filter, Security Audit Log, basic and digest authentication for HTTP/HTTPS, TLS 1.1/1.2, WSSE and digest authentication for Open Network Video Interface |
| Network Storage | NAS (NFS, SMB/CIFS), auto network replenishment (ANR) |
| Client | iVMS-4200, Hik-Connect, Hik-Central |
| Web Browser | Plug-in required live view: IE 10, IE 11 Plug-in free live view : Chrome 57.0+, Firefox 52.0+ Local service: Chrome 57.0+, Firefox 52.0+ |
| Image | |
| Wide Dynamic Range (WDR) | 130 dB |
| SNR | ≥ 52 dB |
| Privacy Mask | 8 programmable polygon privacy masks, mask color or mosaic configurable |
| Day/Night Switch | Day, Night, Auto, Schedule |
| Image Enhancement | BLC, HLC, 3D DNR |
| Image Parameters Switch | Yes |
| Image Settings | Rotate mode, saturation, brightness, contrast, sharpness, gain, white balance adjustable by client software or web browser |
| Interface | |
| Ethernet Interface | 1 RJ45 10 M/100 M self-adaptive Ethernet port |
| On-Board Storage | Built-in memory card slot, support microSD/microSDHC/microSDXC/TF card, up to 256 GB |
| Built-in Microphone | Yes |
| Built-in Speaker | 1.5 W, 10 cm: 95 dB |
| Audio | 1 input (line in), max. input amplitude: 3.3 Vpp, input impedance:4.7 KΩ, interface type: non-equilibrium 1 output (line out), max.output amplitude: 3.3 Vpp, output impedance: 100 Ω, interface type: non-equilibrium |
| Alarm | 1 input, 1 output (max. 24 VDC, 1 A) |
| Reset Key | Yes |
| Event | |
| Basic Event | Motion detection (support alarm triggering by specified target types (human and vehicle)), video tampering alarm, exception (network disconnected, IP address conflict, illegal login, HDD full, HDD error) |
| Smart Event | Line crossing detection, intrusion detection, region entrance detection, region exiting detection (support alarm triggering by specified target types (human and vehicle)), scene change detection |

| | |
|----------------------------------|---|
| Linkage | Upload to NAS/memory card/FTP, notify surveillance center, trigger record, trigger capture, send email |
| Deep Learning Function | |
| Face Capture | Yes |
| General | |
| Power | 12 VDC \pm 25%, 0.63 A, max. 8.5 W, \varnothing 5.5 mm coaxial power plug, reverse polarity protection PoE: 802.3af, Class 3, 36 V to 57 V, 0.24 A to 0.15 A |
| Material | Cover: metal, main body: metal |
| Dimension | \varnothing 138.3 mm \times 120.1 mm (\varnothing 5.4" \times 4.7") |
| Package Dimension | 170 mm \times 170 mm \times 150 mm (6.7" \times 6.7" \times 5.9") |
| Weight | Approx. 900 g (2.0 lb.) |
| With Package Weight | Approx. 1190 g (2.6 lb.) |
| Storage Conditions | -30 °C to 60 °C (-22 °F to 140 °F). Humidity 95% or less (non-condensing) |
| Startup and Operating Conditions | -30 °C to 60 °C (-22 °F to 140 °F). Humidity 95% or less (non-condensing) |
| Language | 33 languages English, Russian, Estonian, Bulgarian, Hungarian, Greek, German, Italian, Czech, Slovak, French, Polish, Dutch, Portuguese, Spanish, Romanian, Danish, Swedish, Norwegian, Finnish, Croatian, Slovenian, Serbian, Turkish, Korean, Traditional Chinese, Thai, Vietnamese, Japanese, Latvian, Lithuanian, Portuguese (Brazil), Ukrainian |
| General Function | Anti-flicker, heartbeat, mirror, password reset via e-mail, pixel counter |
| Approval | |
| EMC | FCC: 47 CFR Part 15, Subpart B CE-EMC: EN 55032: 2015, EN 61000-3-2: 2019, EN 61000-3-3: 2013 + A1: 2019, EN 50130-4: 2011 + A1: 2014 RCM: AS/NZS CISPR 32: 2015 IC: ICES-003: Issue 7 KC: KN32: 2015, KN35: 2015 |
| Safety | UL: UL 62368-1 CB: IEC 62368-1: 2014 + A11 CE-LVD: EN 62368-1: 2014/A11: 2017 |
| Environment | CE-RoHS: 2011/65/EU WEEE: 2012/19/EU Reach: Regulation (EC) No 1907/2006 |
| Protection | IP67: IEC 60529-2013 |

▪ Typical Application

Hikvision products are classified into three levels according to their anti-corrosion performance. Refer to the following description to choose for your using environment.

This model has NO SPECIFIC PROTECTION.

| Level | Description |
|------------------------|--|
| Top-level protection | Hikvision products at this level are equipped for use in areas where professional anti-corrosion protection is a must. Typical application scenarios include coastlines, docks, chemical plants, and more. |
| Moderate protection | Hikvision products at this level are equipped for use in areas with moderate anti-corrosion demands. Typical application scenarios include coastal areas about 2 kilometers (1.24 miles) away from coastlines, as well as areas affected by acid rain. |
| No specific protection | Hikvision products at this level are equipped for use in areas where no specific anti-corrosion protection is needed. |

▪ Available Model

DS-2CD2387G2-LSU/SL (2.8/4 mm)



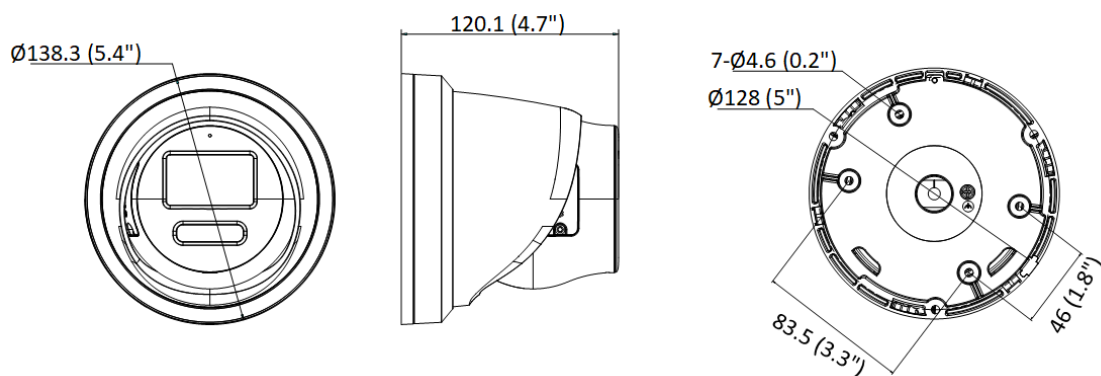



▪ Dimension



Unit: mm (inch)

▪ **Accessory**

▪ **Optional**

| DS-1280ZJ-PT6 Junction Box | DS-1271ZJ-140 Pendant Mount | DS-1276ZJ-SUS Corner Mount | DS-1273ZJ-140B Wall Mount | DS-1275ZJ-SUS Vertical Pole Mount |
|--|---|---|---|---|
|  |  |  |  |  |
| <p data-bbox="165 683 331 750">DS-1273ZJ-140 Wall Mount</p>  | | | | |

Headquarters

No.555 Qianmo Road, Binjiang District,
Hangzhou 310051, China
T +86-571-8807-5998
www.hikvision.com



Follow us on social media to get the latest product and solution information.

