

DS-1227ZJ

In-ceiling Mount Bracket for Dome Camera

Features:

- For in-ceiling mounting
- Aluminum alloy material with surface spray treatment

Dimension:

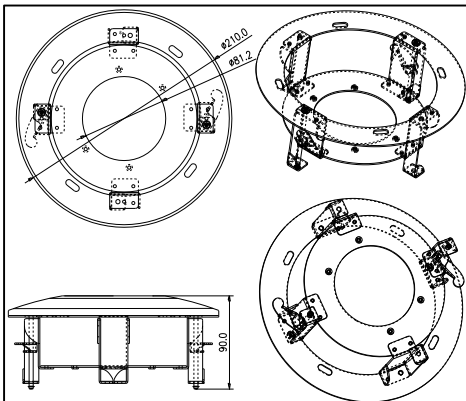

Model Suitable:

DS-2CD7X3PF(NF)-E(I)(Z), DS-2CD793PFW-D-E(I)(Z), DS-2CD793NFW-D-E(I)(Z),
 DS-2CD7X4FWD-E(I)(Z), DS-2CD7XXF-E(I)(Z), DS-2CD783F-EP, DS-2CD4112F-(I),
 DS-2CD4112FWD-(I), DS-2CD4124F-(I), DS-2CD4132FWD-(I), DS-2CD2712F-I(S), DS-2CD2732F-I(S)

Installation Step:

① Choose flat wall for installation and screw up the adaptor

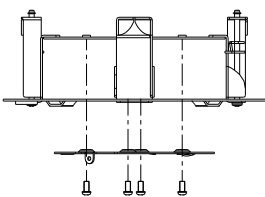

② Complete the adaptor installation

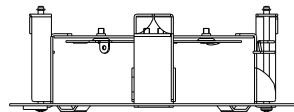

③ Screw up the dome camera

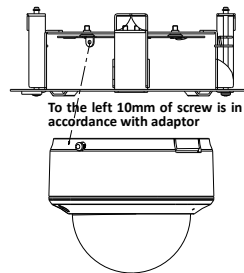

④ Insert the dome camera and bracket to the wall

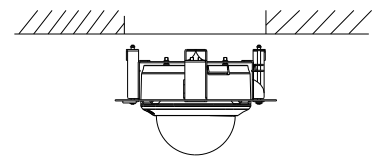

⑤ Screw up the butterfly clamp in clock-wise and clamp the bracket to the wall

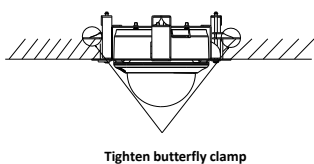

⑥ Tighten 3 screws to fix cap ring

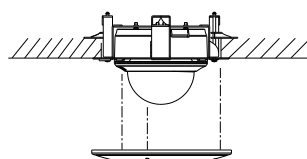

⑦ Installation complete

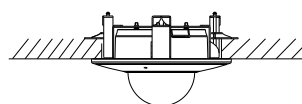

Note: The actual bracket may vary from the picture above.

Order Model:

DS-1227ZJ



Parameter:

Model	DS-1227ZJ
Parameter	In-ceiling Mount Bracket
Appearance	Hikvision White
Range of Application	Dome Camera
Material	Aluminum Alloy
Dimension	Φ 210×90mm
Weight	600g

Notice:

- The bracket should be installed on flat wall
- The wall must be capable of supporting more than 3 times the weight of camera and bracket
- Load capacity of bracket is 4.5KG