

2TMD041600D0130 | 04.11.2020

Product manual ABB-Welcome

M22341-._M22343-. Basic 4.3" video hands-free indoor station



1	Notes on the instruction manual	4
2	Safety	4
3	Intended use	4
4	Environment	5
4.1	ABB devices	5
5	Product description	6
5.1	Control elements	6
5.2	Terminal description	8
6	Technical data	9
7	Mounting/Installation	10
7.1	Requirement for the electrician	10
7.2	General installation instructions	11
7.3	Mounting	12
7.3.1	Installation height	12
7.3.2	Dismantling	12
7.3.3	Surface-mounted installation	13
7.3.4	Desktop installation	14
8	Commissioning	15
8.1	Common operation	15
8.2	Intercom settings	16
8.3	Switch actuator settings	17
8.4	Program button settings	18
8.5	Auto unlock settings	19
8.6	Unlock password settings	20
8.7	Ringtone settings	21
8.8	Volume settings	22
8.9	Date and time settings	23
8.10	Other settings	24
8.11	History	25
8.12	Camera list	26
8.13	Language	33
8.14	Information	34
8.15	Restoring to factory default	35
9	Operation	36
9.1	Incoming call	36
9.2	Intercom	38
9.3	Call guard unit	39
9.4	Control switch actuator	40

10 Notice41

1 Notes on the instruction manual

Please read through this manual carefully and observe the information it contains. This will assist you in preventing injuries and damage to property and ensure both reliable operation and a long service life for the device.

Please keep this manual in a safe place. If you pass the device on, also pass on this manual along with it. ABB accepts no liability for any failure to observe the instructions in this manual.

2 Safety



Warning

Electric voltage!

Dangerous currents flow through the body when coming into direct or indirect contact with live components.

This can result in electric shock, burns or even death.

- Disconnect the mains power supply prior to installation and/or disassembly!
- Permit work on the 100-240 V supply system to be performed only by specialist staff!

3 Intended use

This device is an integral part of the ABB-Welcome door communication system and operates exclusively with components from this system. The device must only be installed in dry indoor rooms.

Cleaning



Caution

Risk of damage to the screen surface

The screen surface can be damaged by hard or sharp objects!

Never use such objects for entries on the touch screen monitor.

- Use your finger or a plastic stylus.

The screen surface can be damaged by cleaning fluids or abrasive agents!

- Clean the surfaces using a soft cloth and commercially available glass cleaner.

- Never use abrasive cleaning agents.

4 Environment



Consider the protection of the environment!

Used electric and electronic devices must not be disposed of with household waste.

- The device contains valuable raw materials that can be recycled. Therefore, dispose of the device at the appropriate collecting facility.

4.1 ABB devices

All packaging materials and devices from ABB bear the markings and test seals for proper disposal. Always dispose of the packing materials and electric devices and their components via an authorized collection facility or disposal company.

ABB products meet the legal requirements, in particular the laws governing electronic and electrical devices and the REACH ordinance.

(EU-Directive 2012/19/EU WEEE and 2011/65/EU RoHS)

(EU-REACH ordinance and law for the implementation of the ordinance (EG) No.1907/2006)

5 Product description

5.1 Control elements

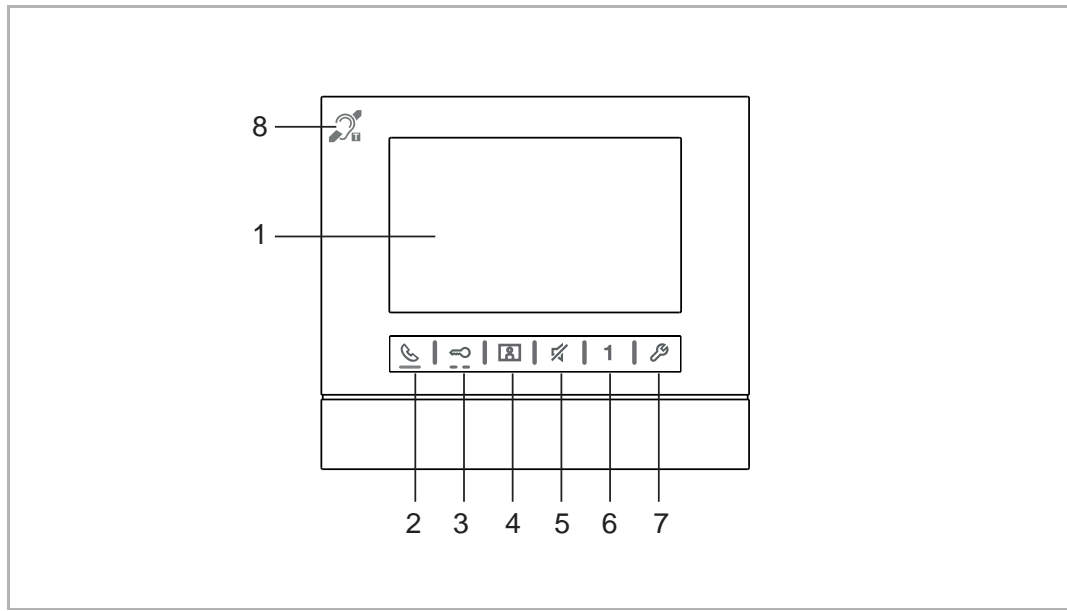

No.	Description
1	4.3" Color display
2	<p>Communication button</p> <ul style="list-style-type: none"> ▪ When an incoming call, press this button to initiate a communication, press this button again to end the call. ▪ In standby status, press this button to initiate an intercom, call guard unit or release the switch actuator. <ul style="list-style-type: none"> – The backlit LED of this button flashes slowly to indicate an incoming call. – The backlit LED of this button lights on to indicate a conversation is in progress. – The backlit LED of this button flashes rapidly to indicate system is busy.
3	<p>Unlock button</p> <ul style="list-style-type: none"> ▪ Press this button to release the lock at any time. ▪ Hold this button more than 10 seconds to enable/disable the "Auto-unlock" function. If the function is enabled, the lock will be released automatically after the indoor station rings 5 seconds and this function will be available for 10 hours from the moment the function is enabled. <ul style="list-style-type: none"> – The backlit LED of this button lights on to indicate the "Auto-unlock" function is enabled. – The backlit LED of this button flashes fast to indicate the lock is released over the set time.
4	<p>Surveillance button</p> <ul style="list-style-type: none"> ▪ In standby status, press this button to display the image from the default outdoor station, press this button again to display the next image from other outdoor stations or camera interfaces. ▪ When the screen is on, hold this button to take a snapshot manually. ▪ In standby status, if the backlit LED of this button flashes white, hold this button to view the missed calls.

No.	Description
5	<p>Mute button</p> <ul style="list-style-type: none"> ▪ In standby status, press this button to mute the ringtone of this indoor station. ▪ In standby status, hold this button to mute the ringtone of all indoor stations in the same apartment. ▪ When an incoming call, press this button to reject the call. ▪ During the conversation, press this button to mute the microphone. <p>– The backlit LED of this button lights on to indicate the mute status.</p>
6	<p>Programmable button</p> <ul style="list-style-type: none"> ▪ This programmable button is set to release the 2nd lock by default. ▪ In standby status, hold this button for 3 seconds to send an SOS alarm to the guard unit. The backlit LED of this button flashes white slowly to indicate success. ▪ This programmable button can be set to other function e.g. call guard unit, intercom.
7	<p>Setting button</p> <p>In standby status, press this button to enter the system setting screen. The backlit LED of this button flashes fast to indicate system is busy.</p>
8	Induction loop (only for M22343-.)

Induction loop

The induction loop is used for hearing-impaired persons. They can wear a hearing aid to hear the voice from the outdoor station or the indoor station.

The indoor station supports the hearing aids with "T" function and the maximum distance between them is around 35 cm.

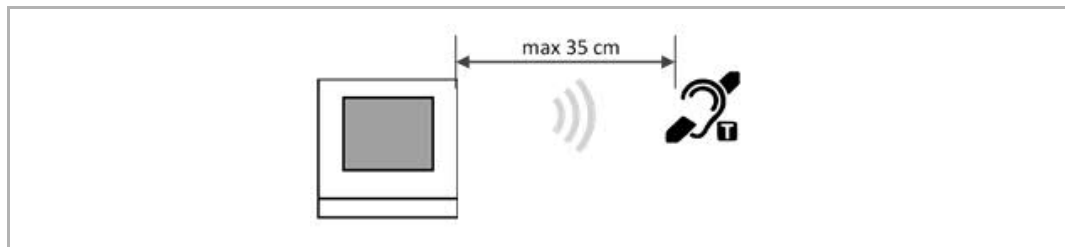

5.2 Terminal description

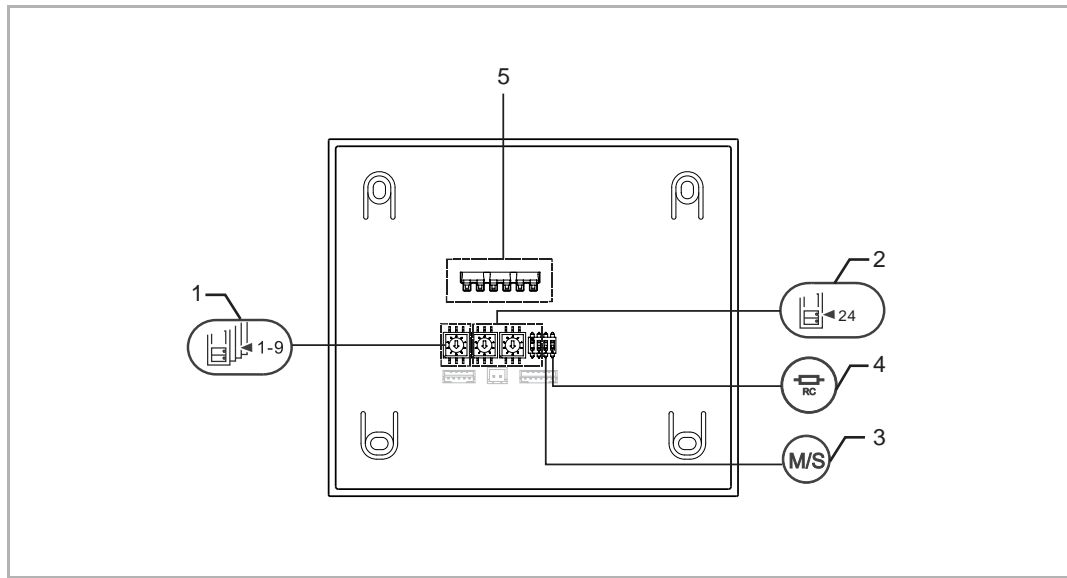

No.	Description
1	Station Select switch to set the address of the default outdoor station.
2	X10 X1 Selector switches to set the address (tens and units digits) of the indoor station. X200 X100 Dip switches to set the address (hundreds digits) of the indoor station.
3	Master/slave function Only one indoor station in an apartment can be set to "Master" (ON=Master). All other indoor stations in the same apartment must be set to "Slave (OFF=slave).
4	Terminal resistor In video installations or mixed audio and video installations, the switch must be set as ON at the last device of the bus line.
5	a b = BUS connection  doorbell connection DC GND =Additional power supply
6	Connector to an induction loop

6 Technical data

Designation	Value
Display resolution	480 x 272
Display size	4.3"
Operating temperature	-10 °C...+55 °C
Storage temperature	-40 °C...+70 °C
Protection	IP 30
Single-wire clamps	2 x 0.28 mm ² - 2 x 0.75 mm ²
Fine-wire clamps	2 x 0.28 mm ² - 2 x 0.75 mm ²
Bus voltage	20-30 V ⁼⁼
Size	154 mm x 134 mm x 23 mm

7 Mounting/Installation



Warning

Electric voltage!

Dangerous currents flow through the body when coming into direct or indirect contact with live components.

This can result in electric shock, burns or even death.

- Disconnect the mains power supply prior to installation and/or disassembly!
- Permit work on the 100-240 V supply system to be performed only by specialist staff!

7.1 Requirement for the electrician



Warning

Electric voltage!

Install the device only if you have the necessary electrical engineering knowledge and experience.

- Incorrect installation endangers your life and that of the user of the electrical system.
- Incorrect installation can cause serious damage to property, e.g. due to fire.

The minimum necessary expert knowledge and requirements for the installation are as follows:

- Apply the "five safety rules" (DIN VDE 0105, EN 50110):
 1. Disconnect
 2. Secure against being re-connected
 3. Ensure there is no voltage
 4. Connect to earth and short-circuit
 5. Cover or barricade adjacent live parts.
- Use suitable personal protective clothing.
- Use only suitable tools and measuring devices.
- Check the type of supply network (TN system, IT system, TT system) to secure the following power supply conditions (classic connection to ground, protective grounding, necessary additional measures, etc.).

7.2 General installation instructions

- Terminate all branches of the wiring system via a connected bus device (e.g., indoor station, outdoor station, system device).
- Do not install the system controller directly next to the bell transformer and other power supplies (to avoid interference).
- Do not install the wires of the system bus together with 100-240 V wires.
- Do not use common cables for the connecting wires of the door openers and wires of the system bus.
- Avoid bridges between different cable types.
- Use only two wires for the system bus in a four-core or multi-core cable.
- When looping, never install the incoming and outgoing bus inside the same cable.
- Never install the internal and external bus inside the same cable.

7.3 Mounting

7.3.1 Installation height

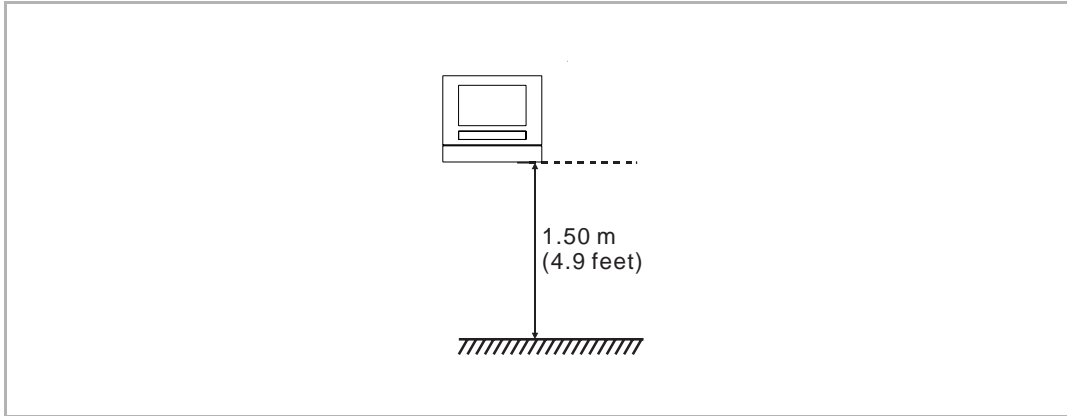

7.3.2 Dismantling

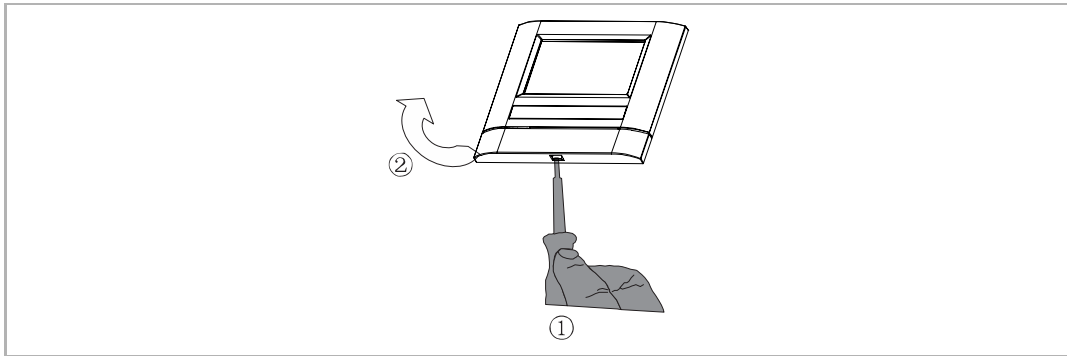

7.3.3 Surface-mounted installation

Surface-mounted box (unit: mm)

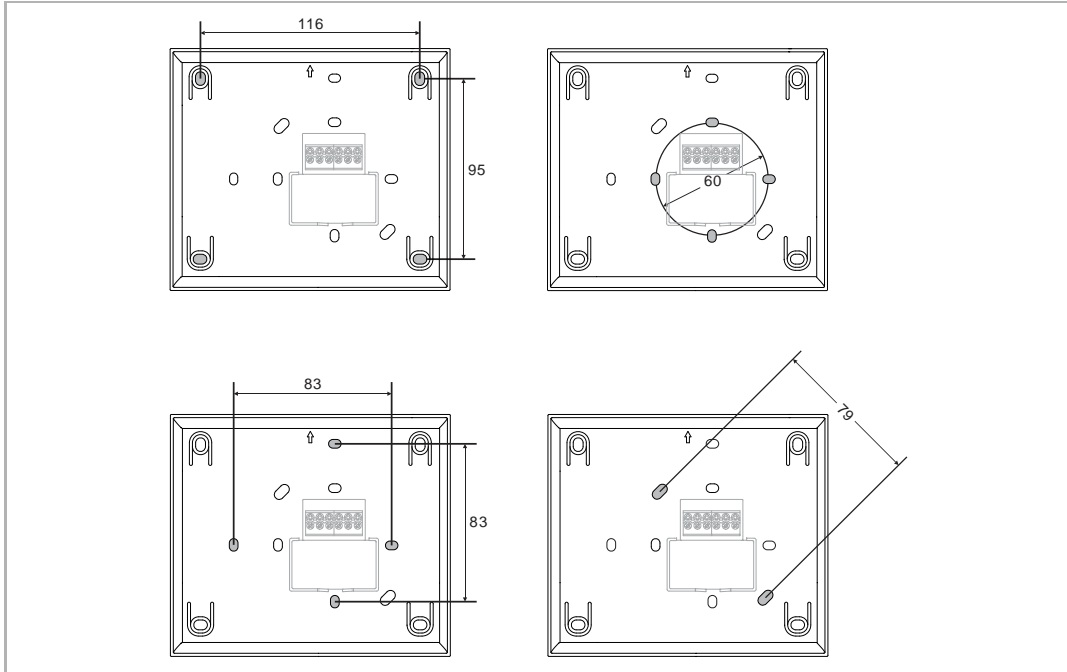

Installation

1. Mounted on the wall

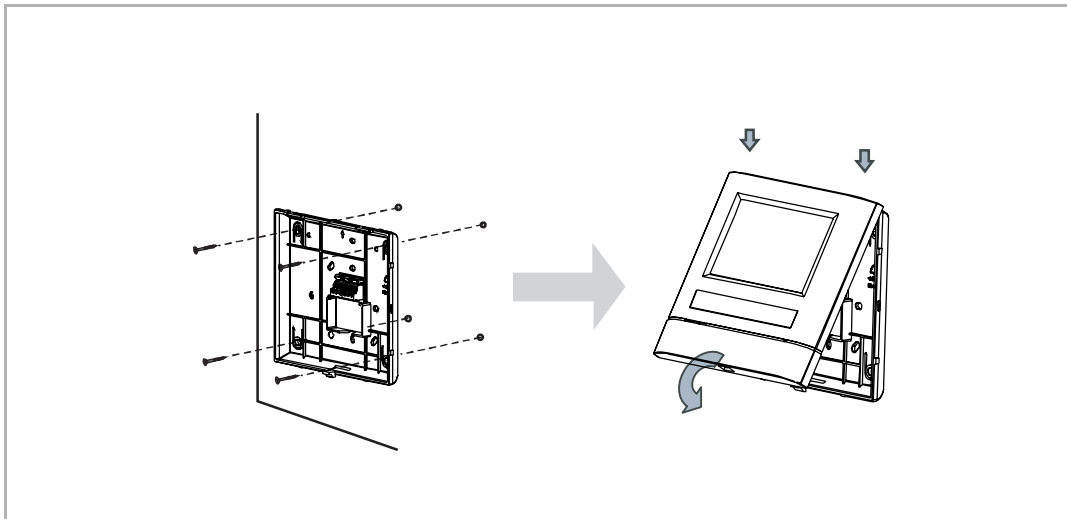

2. Mounted with flush-mounted box

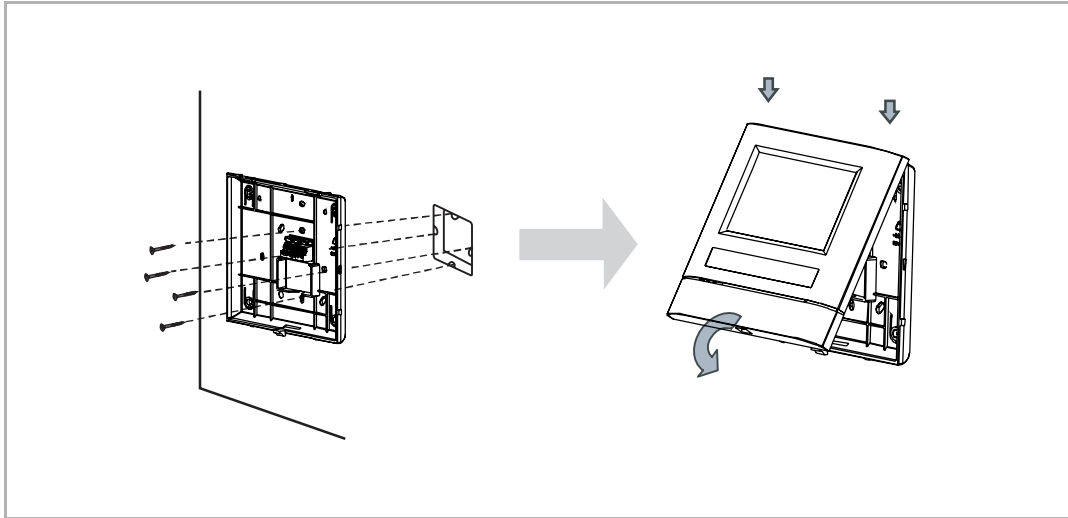

7.3.4 Desktop installation

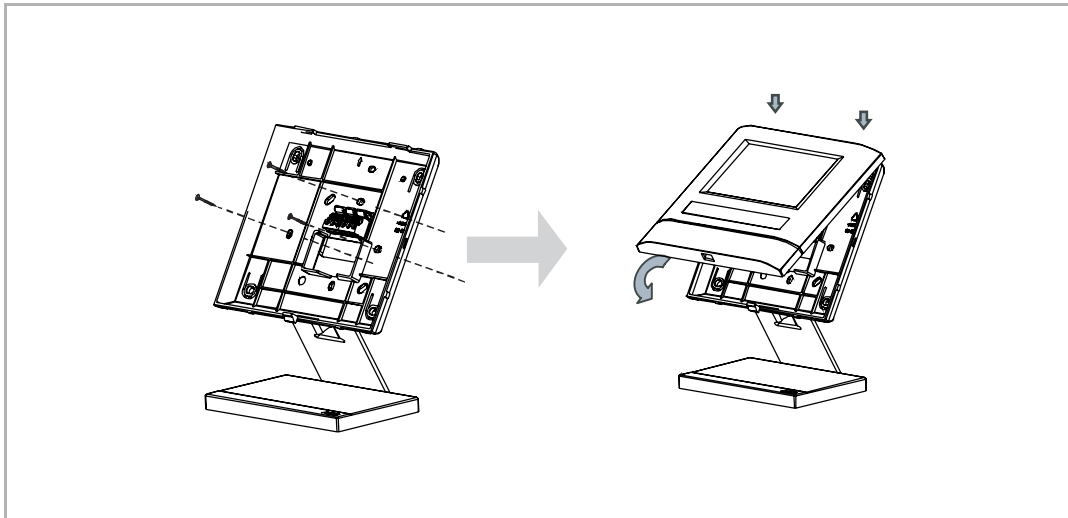

8 Commissioning

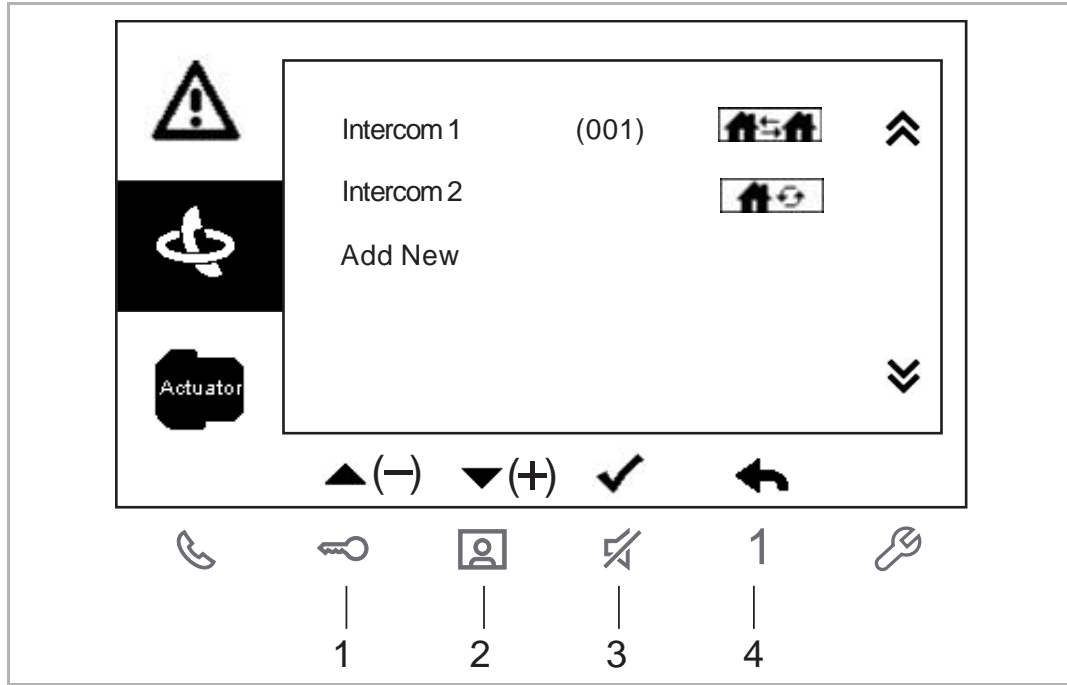

8.1 Common operation

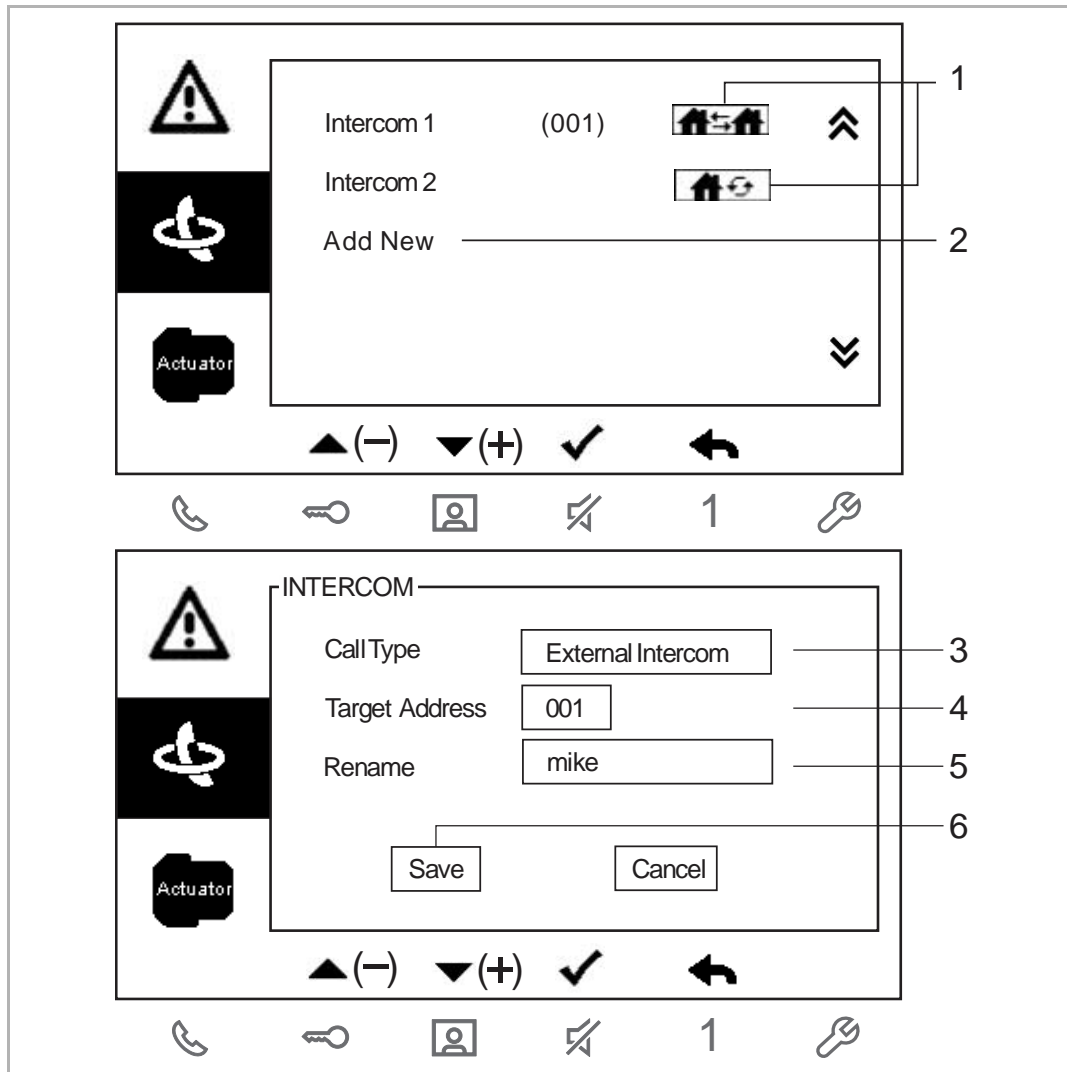

No.	Functions
1	In normal status, press this button to select the previous item. In setting status, press this button to change the setting or scroll down the letter/number, hold the button to scroll down the letter/number quickly.
2	In normal status, press this button to select the next item. In setting status, press this button to change the setting or scroll up the letter/number, hold the button to scroll up the letter/number quickly.
3	In normal status, press this button to enter the setting. In setting status, press this button to confirm the setting.
4	In normal status, press this button to turn back to the previous screen. In setting status, press this button to cancel the setting.

8.2 Intercom settings



No.	Functions
1	Display the existing intercoms.  means an intercom between different apartments.  means an intercom in the same apartment.
2	Click to add a new intercom (maximum 32).
3	Call type In setting status, press "+" or "-" button to set the call type between "External Intercom" and "Internal Intercom".
4	When the call type is set to "External Intercom", in setting status, press "+" or "-" button to set the address of target indoor station (001-250).
5	In setting status, press "+" or "-" button to set a new name.
6	In normal status, press "✓" button to save the settings.

8.3 Switch actuator settings

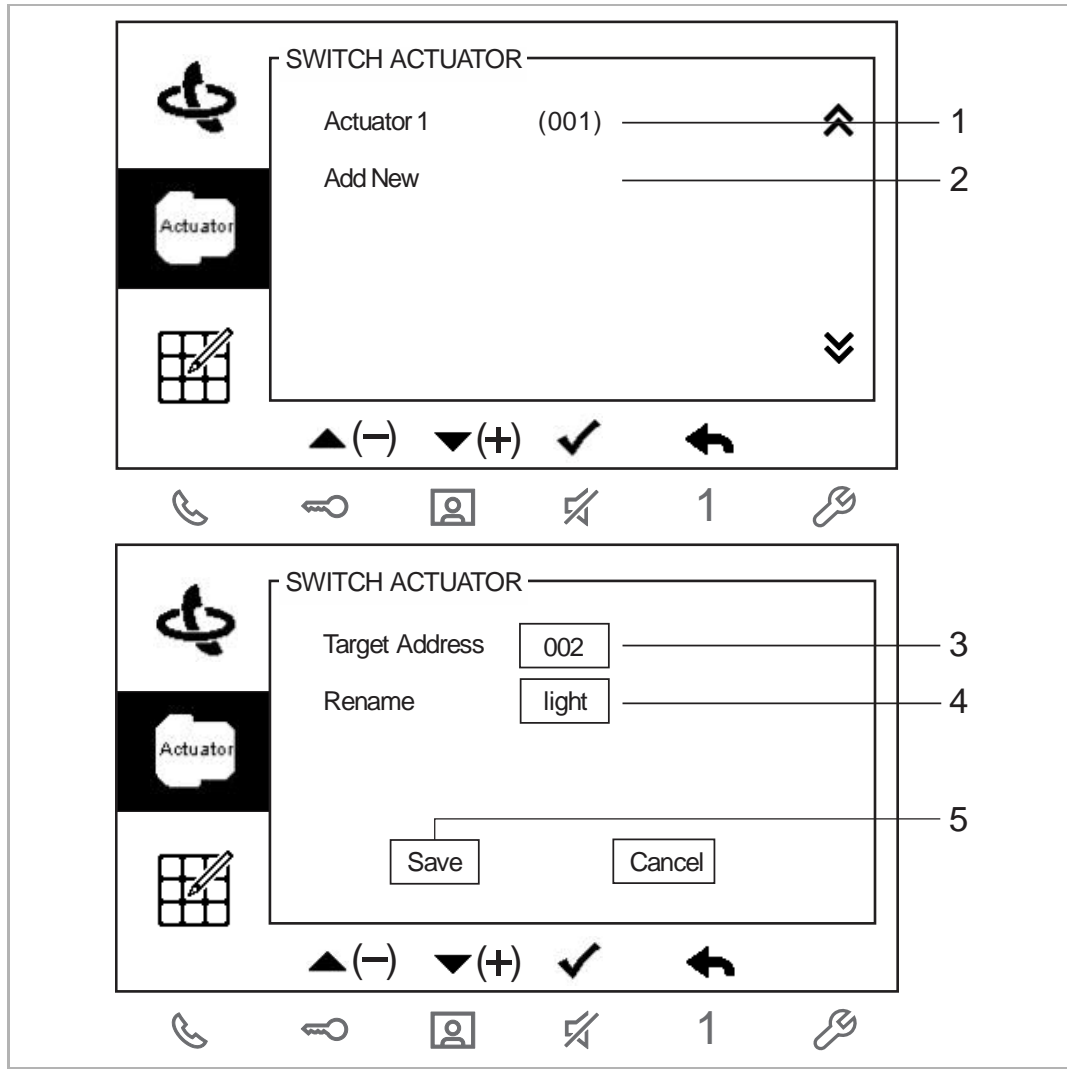

No.	Description
1	Display the existing switch actuators.
2	Click it to add a new switch actuator (maximum 10).
3	Target address In setting status, press "+" or "-" button to set the address of target switch actuator (001-199).
4	In setting status, press "+" or "-" button to set a new name.
5	In normal status, press "✓" button to save the settings.

8.4 Program button settings

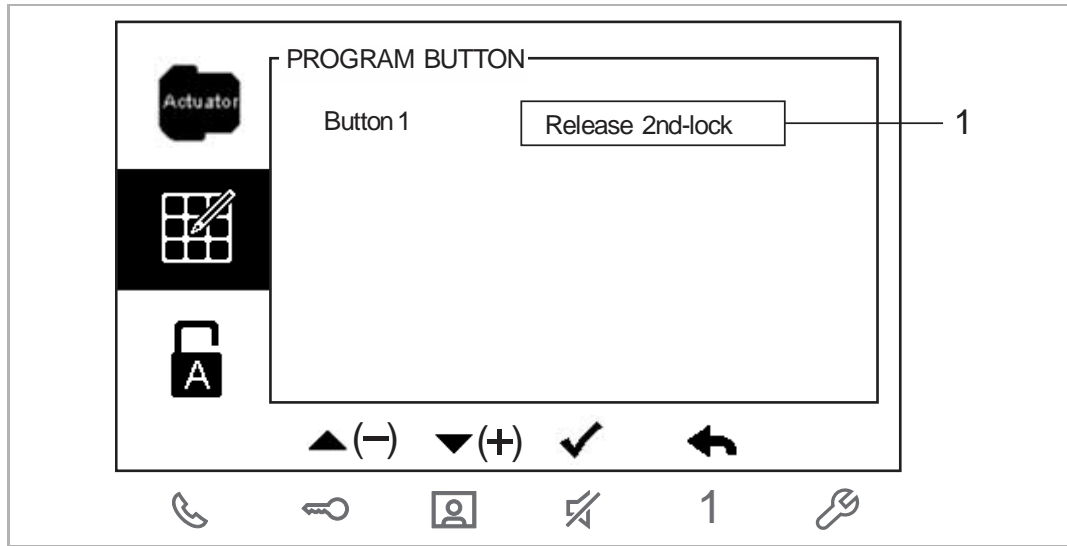

No.	Description
1	<p>Program button function</p> <p>In setting status, press "+" or "-" button to set the function for the program button, e.g. releasing second lock, calling guard unit, intercom call, releasing the existing switch actuator.</p>

8.5 Auto unlock settings

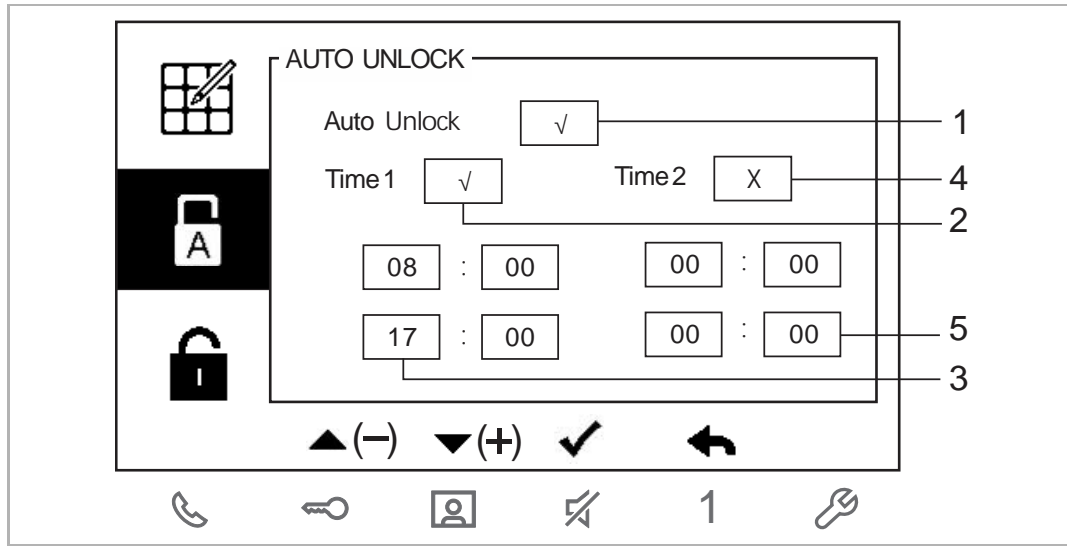

No.	Description
1	In setting status, press "+" or "-" button to enable/disable the function.
2	Time 1 function In setting status, press "+" or "-" button to enable/disable the function.
3	Time 1 settings In setting status, press "+" or "-" button to set start time and end time.
4	Time 2 function In setting status, press "+" or "-" button to enable/disable the function.
5	Time 2 settings In setting status, press "+" or "-" button to set start time and end time.



Note

If the "Auto unlock" function is enabled, the "Call forward" function will be disabled automatically.

This function can only be set on the master indoor station.

8.6 Unlock password settings

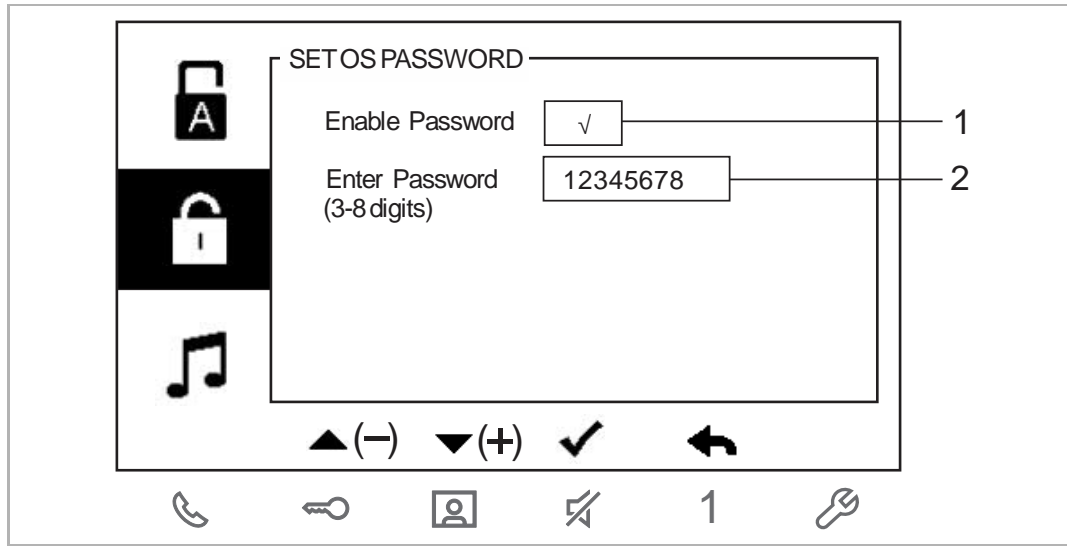

No.	Description
1	In setting status, press "+" or "-" button to enable/disable the function.
2	Unlock password In setting status, press "+" or "-" button to set the password (3-8 digits).



Note

This function can only be set on the master indoor station.

8.7 Ringtone settings

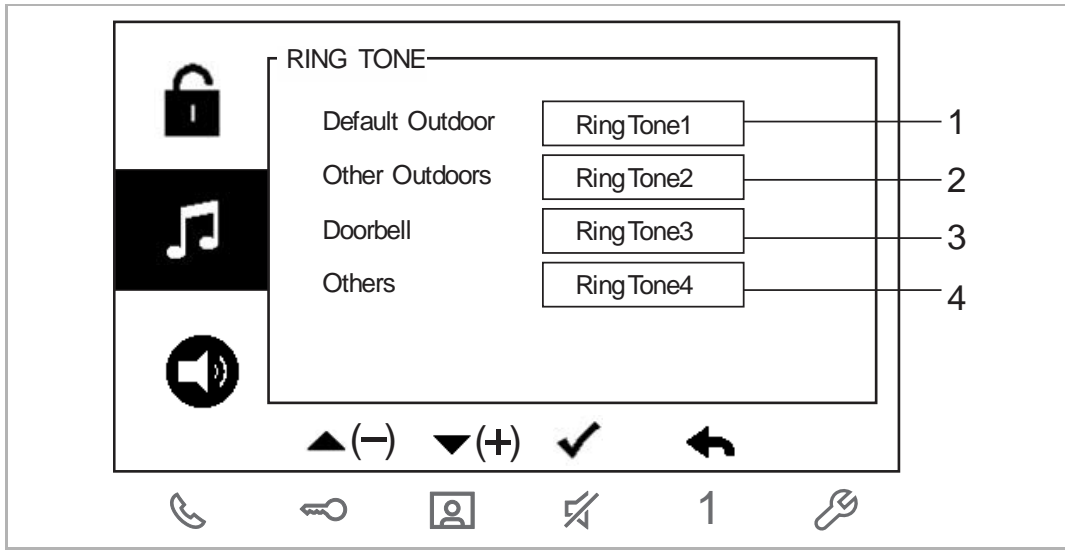

No.	Description
1	In setting status, press "+" or "-" button to select a ring tone for default outdoor station.
2	In setting status, press "+" or "-" button to select a ring tone for other outdoor stations.
3	In setting status, press "+" or "-" button to select a ring tone for doorbell.
4	In setting status, press "+" or "-" button to select a ring tone for other devices, e.g. guard units and indoor stations.

8.8 Volume settings

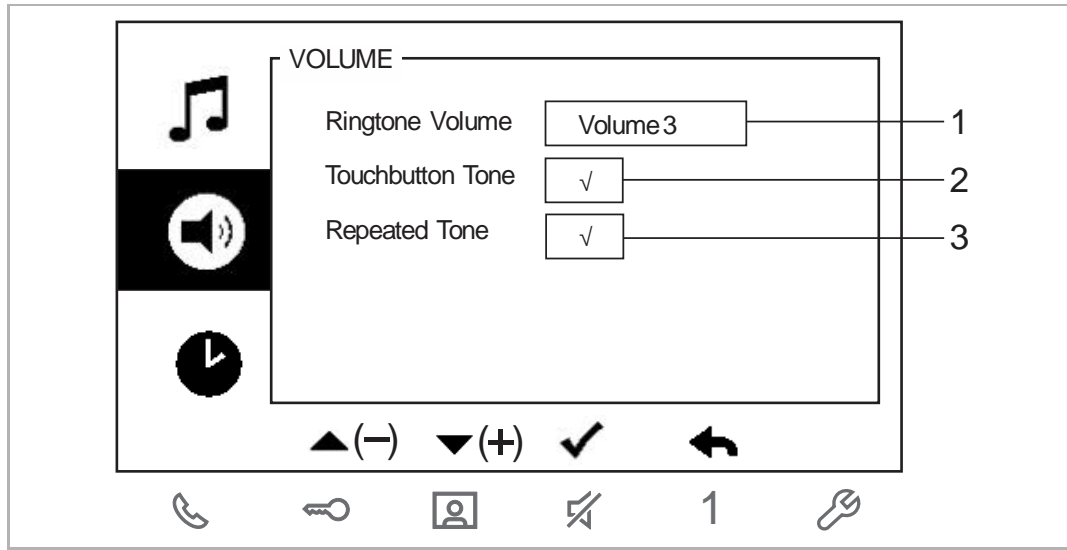

No.	Description
1	In setting status, press "+" or "-" button to set the volume.
2	In setting status, press "+" or "-" button to enable/disable the function.
3	In setting status, press "+" or "-" button to enable/disable the function.

8.9 Date and time settings

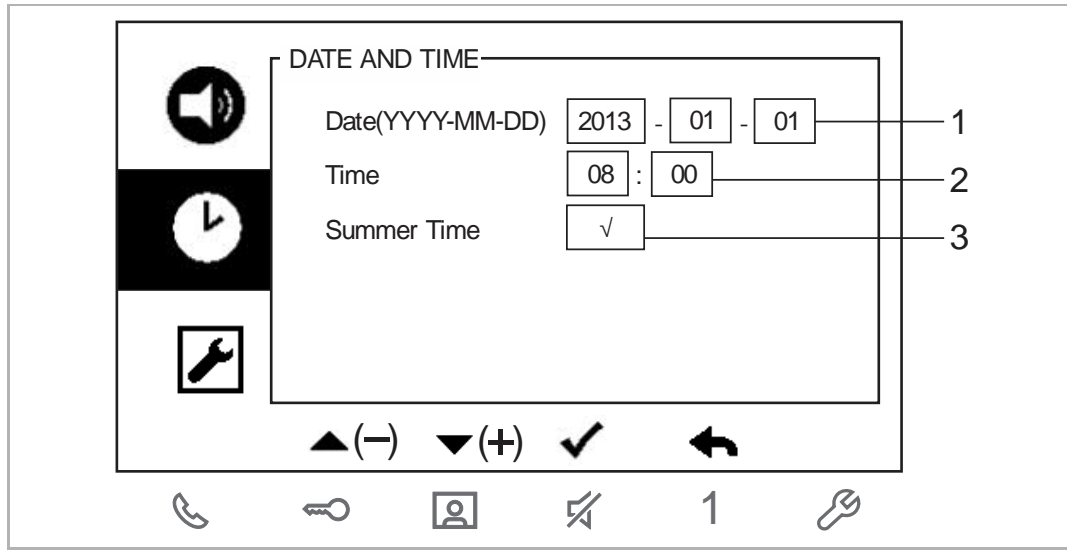

No.	Description
1	In setting status, press "+" or "-" button to set the date.
2	In setting status, press "+" or "-" button to set the time.
3	In setting status, press "+" or "-" button to enable/disable the function.



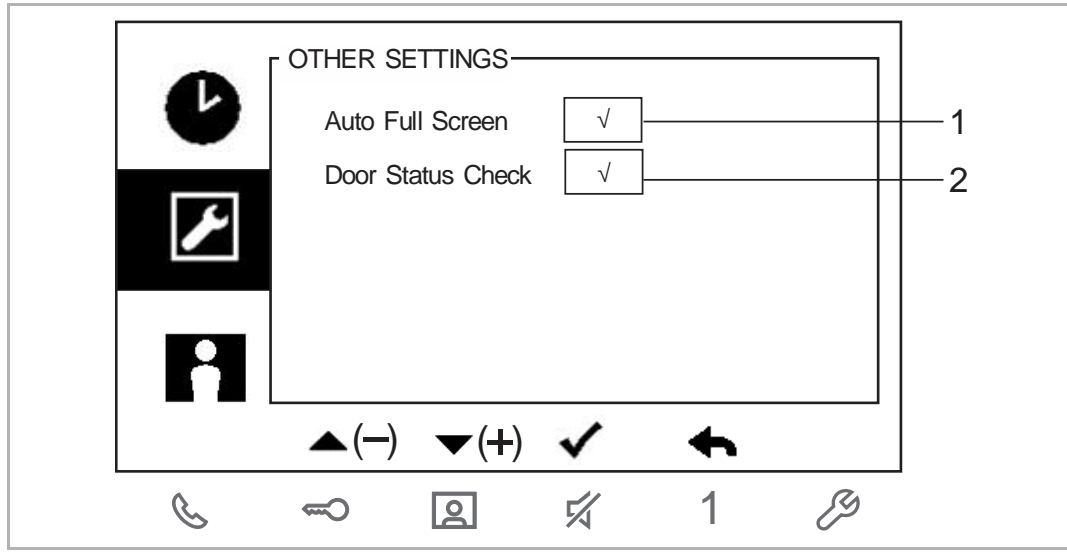

8.10 Other settings

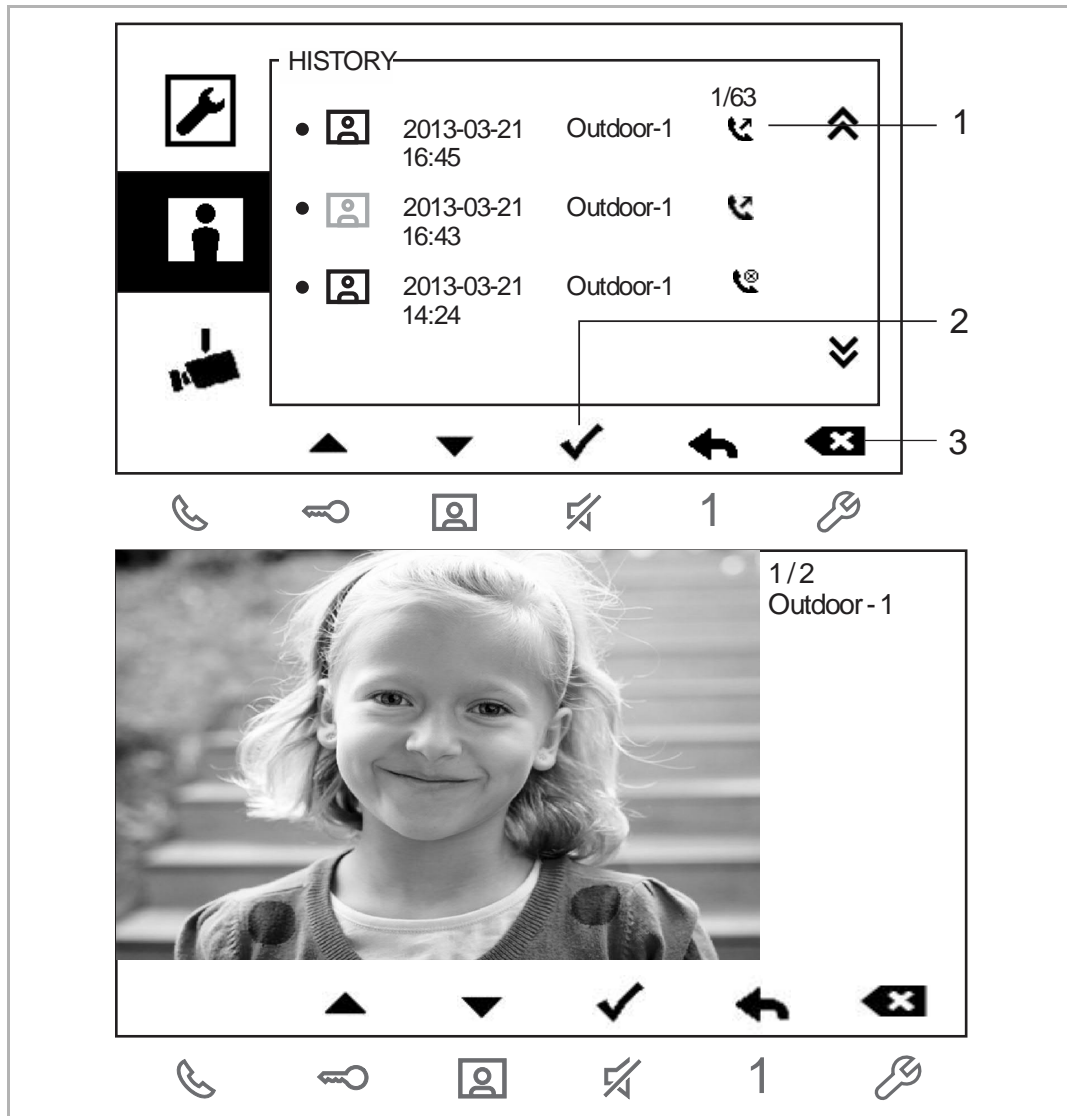

No.	Description
1	In setting status, press "+" or "-" button to enable/disable the function.
2	In setting status, press "+" or "-" button to enable/disable the function (a sensor should be connected to the outdoor station before use).

8.11 History



No.	Description
1	Call records are displayed on the screen. (Up to 100 records are supported). "  " will be displayed if the "Auto-snapshots" function is enabled.  means dialing a call  means receiving a call  means a missed call
2	Press this button to view the details of the record.
3	Press this button to delete this record.



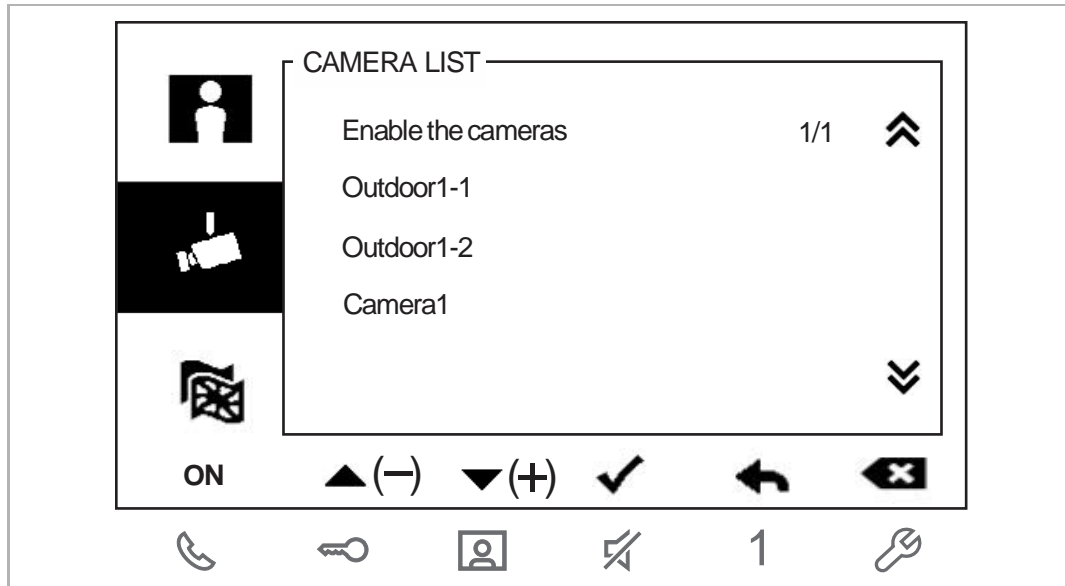

8.12 Camera list

By default, in standby status, when you repeatedly press "  " button, you can view all images from the outdoor stations and the cameras. If you only want to view some images from them, you need to enable the "Camera list" function to edit your camera list.

Enable the "Camera list" function



Please follow the steps below:

- [1] Press "  " button to access the operation screen.
- [2] Press "  " or "  " to select "  " on the left list.
- [3] Press "  " to enable the function, "Enable the cameras" displayed on the screen indicates the function is enabled.

Edit the camera list

1. Remove the camera from the camera list

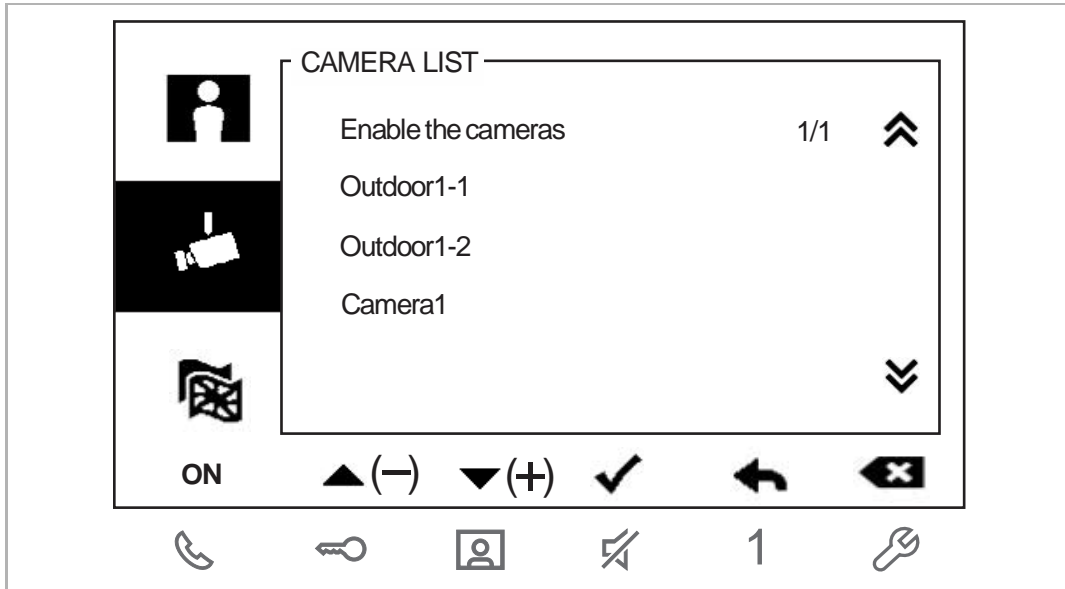







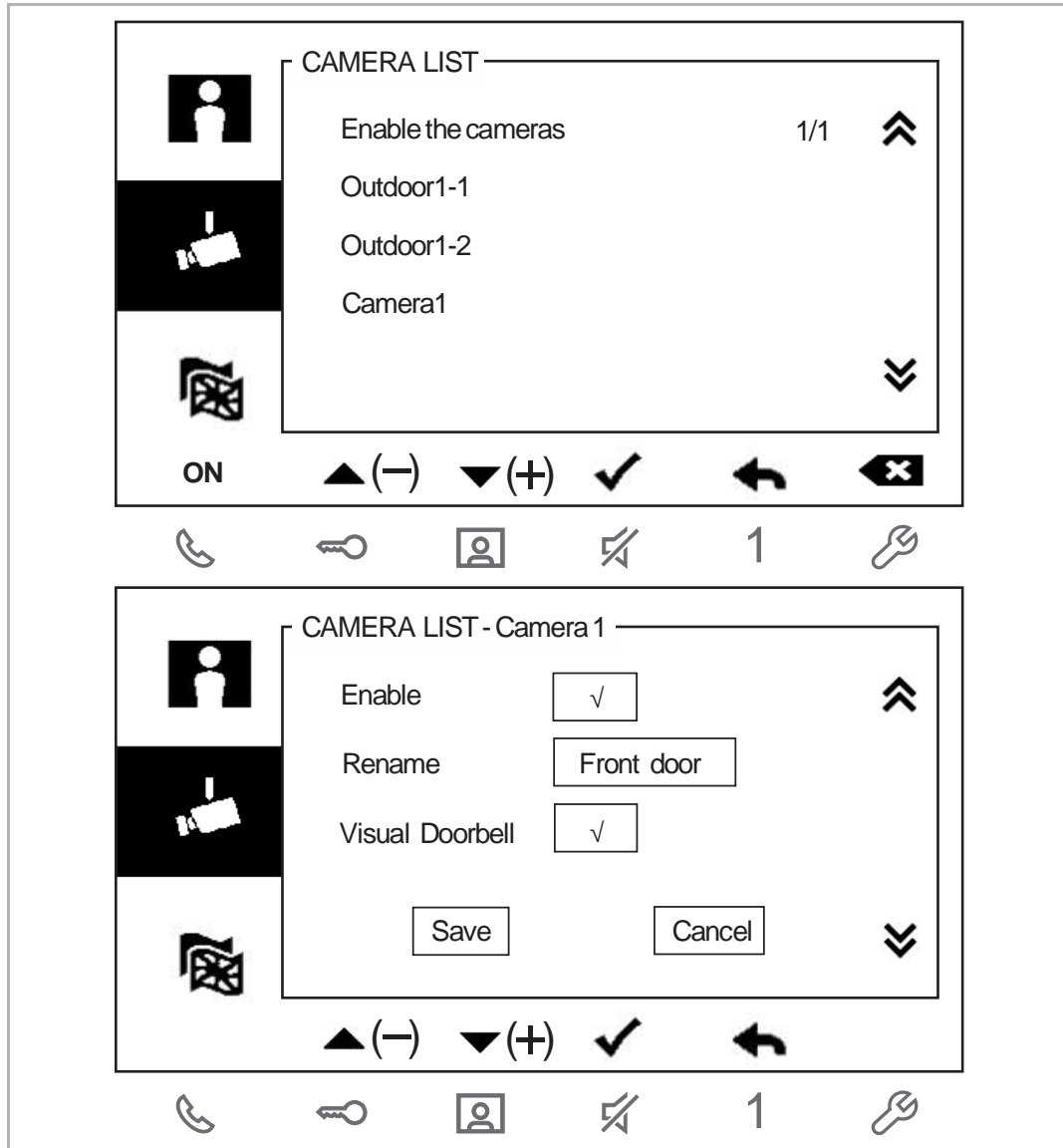



Please follow the steps below:

- [1] In standby status, press " 🔑 " button to access the communication screen.
- [2] Press " ▲ " or " ▼ " to select " 📷 " on the left list and then press " ✓ " to access the camera list.
- [3] Press " ▲ " or " ▼ " to select the designated camera and then press " ⬅️ X " twice to remove the camera.

2. Hide/unhide the camera from the camera list









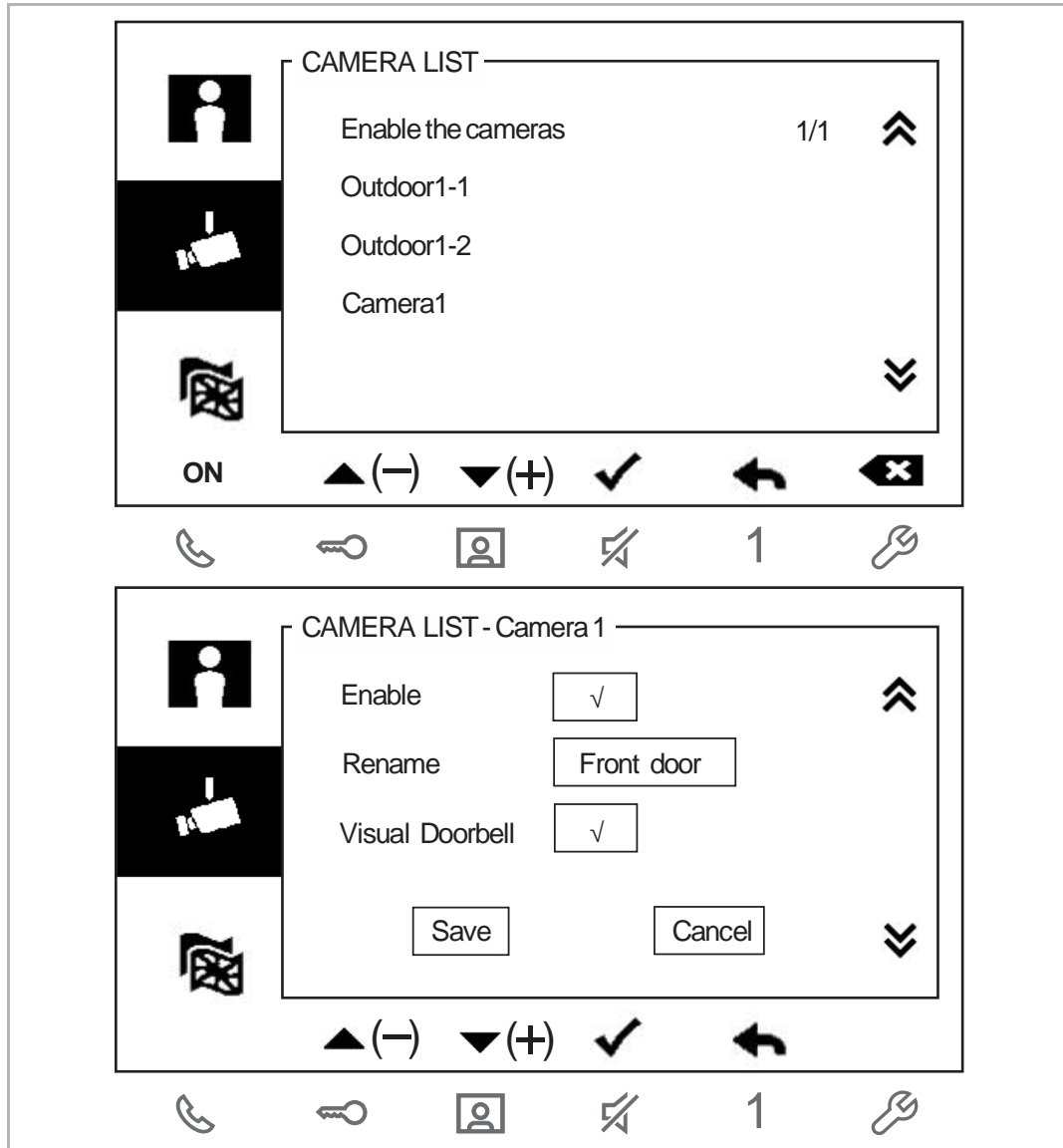



Please follow the steps below:

- [1] In standby status, press "  " button to access the operation screen.
- [2] Press "  " or "  " to select "  " on the left list and then press "  " to access the camera list.
- [3] Press "  " or "  " to select the designated camera, and then press "  " to access the detailed settings.
- [4] Press "+" or "-" button to hide/unhide the camera from the camera list.
- [5] Press "  " to select "Save" and then press "  " to save the settings.

3. Rename the camera from the camera list



Please follow the steps below:

- [1] In standby status, press "  " button to access the operation screen.
- [2] Press "  " or "  " to select "  " on the left list and then press "  " to access the camera list.
- [3] Press "  " or "  " to select the designated camera, and then press "  " to access the detailed settings.
- [4] Press "  " to select "Rename" and then press "+" or "-" button to rename the camera.
- [5] Press "  " to select "Save" and then press "  " to save the settings.

4. Visual doorbell

Overview

In some case, there is no camera on the outdoor station. When the doorbell is pressed, you want the indoor station to display the image from the designated camera connected to the camera interface.







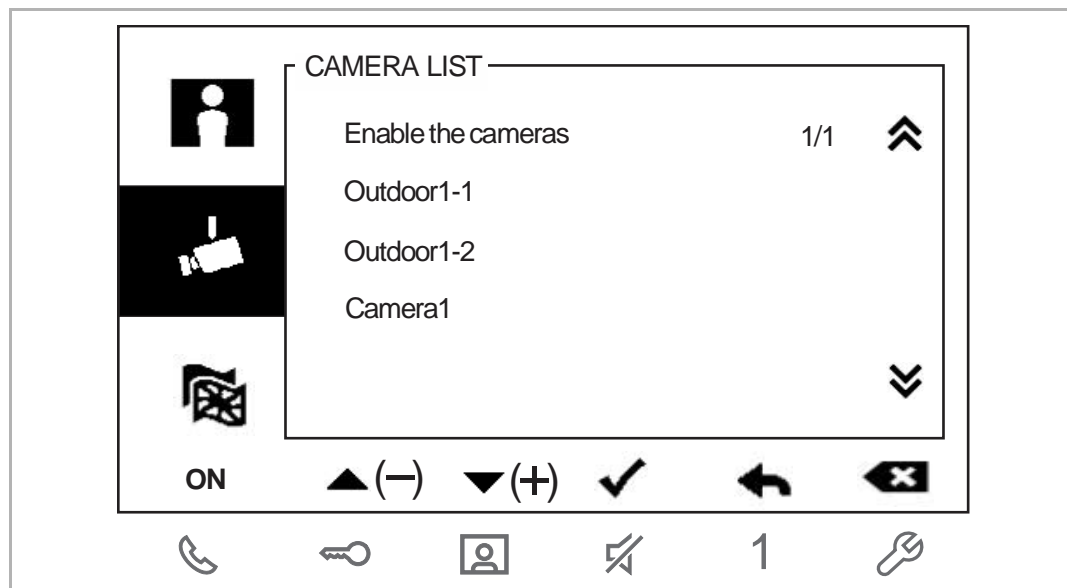

Precondition

- The camera is connected to the camera interface.
- Camera interface works at "mode=4" and is related to the indoor station. Please see the product manual of camera interface for more details.

Enable the "Visual doorbell" function



Please follow the steps below:

- [1] In standby status, press "  " button to access the operation screen.
- [2] Press "  " or "  " to select "  " on the left list and then press "  " to access the camera list.
- [3] Press "  " or "  " to select the designated camera, and then press "  " to access the detailed settings.

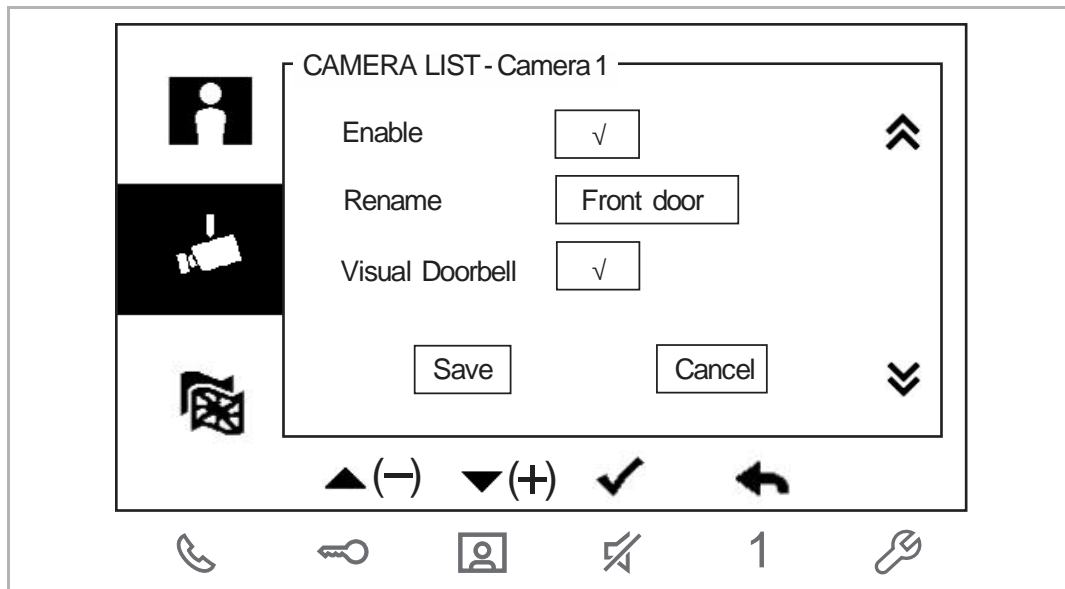





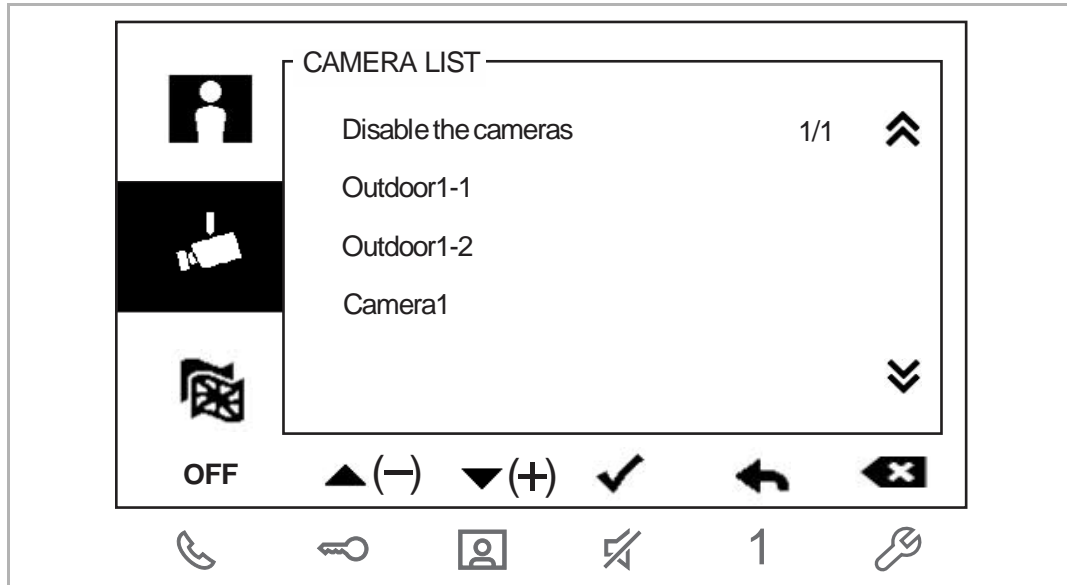

- [4] Press " ▼ " to select "Visual Doorbell" and then press "+" or "-" button to enable the function.
- [5] Press " ▼ " to select "Save" and then press " ✓ " to save the settings.

5. Find out the camera we removed before



Please follow the steps below:

- [1] In standby status, press "  " button to access the operation screen.
- [2] Press "  " or "  " to select "  " on the left list.
- [3] Press "  " to disable the function, "Disable the cameras" will be displayed on the screen.
- [4] Repeatedly press "  " button to view all the images from the outdoor station and the cameras.
- [5] Then when you turn back to camera list, all the lost cameras are displayed on the screen again.

8.13 Language

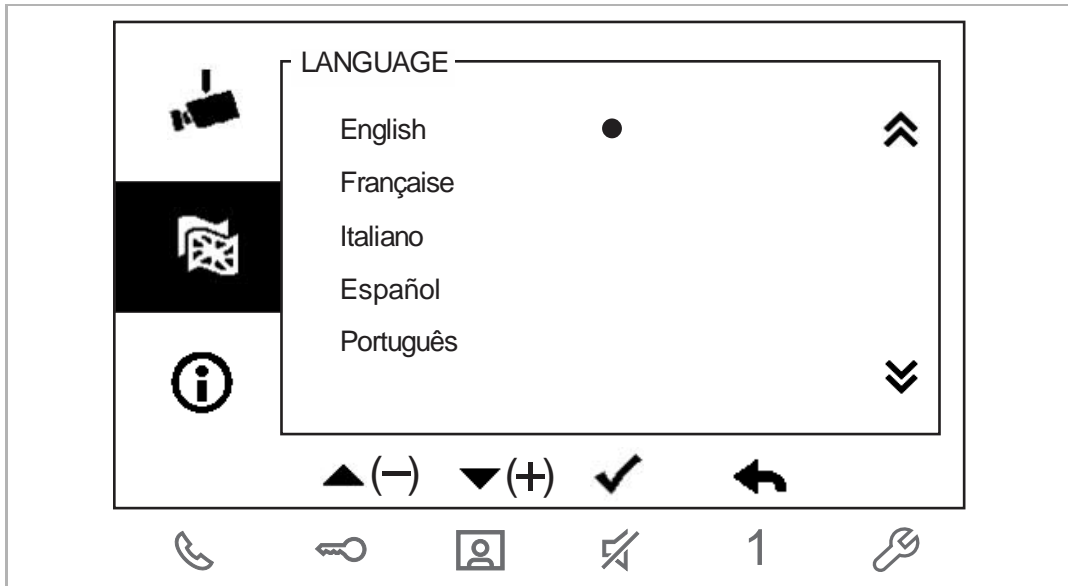

8.14 Information

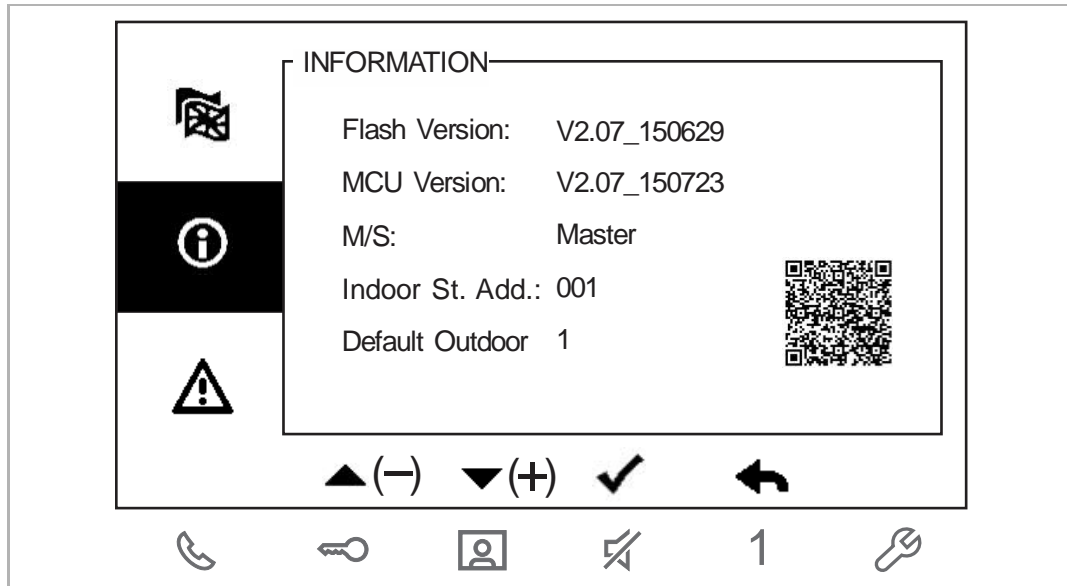

You can use your mobile to scan QR code to obtain the product manual on the website.

8.15 Restoring to factory default

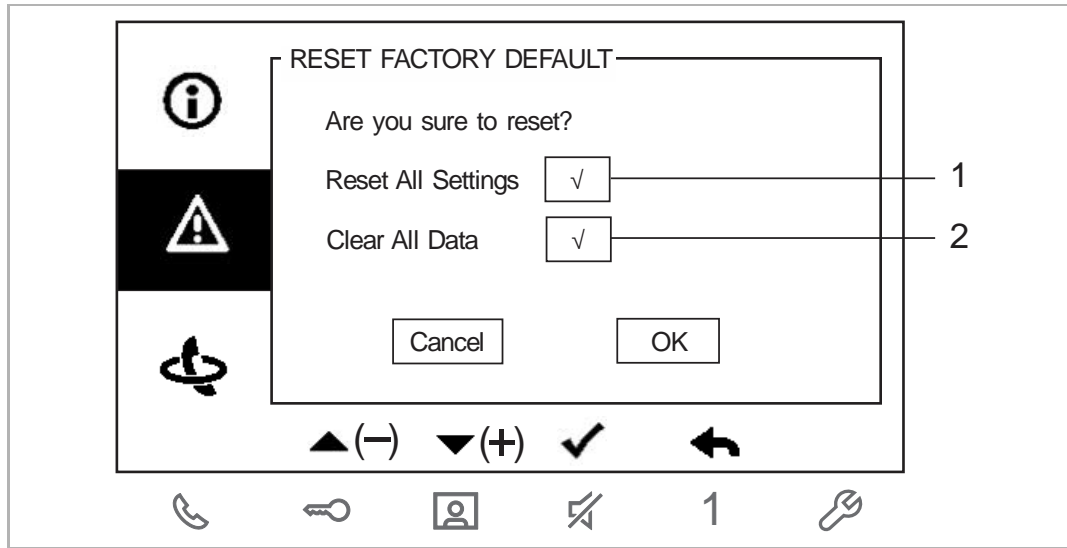

No.	Description
1	Reset all settings: Reset all settings to factory default. But data like history records, existing intercoms and existing switch actuators will not be reset.
2	Clear all data: Reset all the settings and data to factory default.

9 Operation

9.1 Incoming call

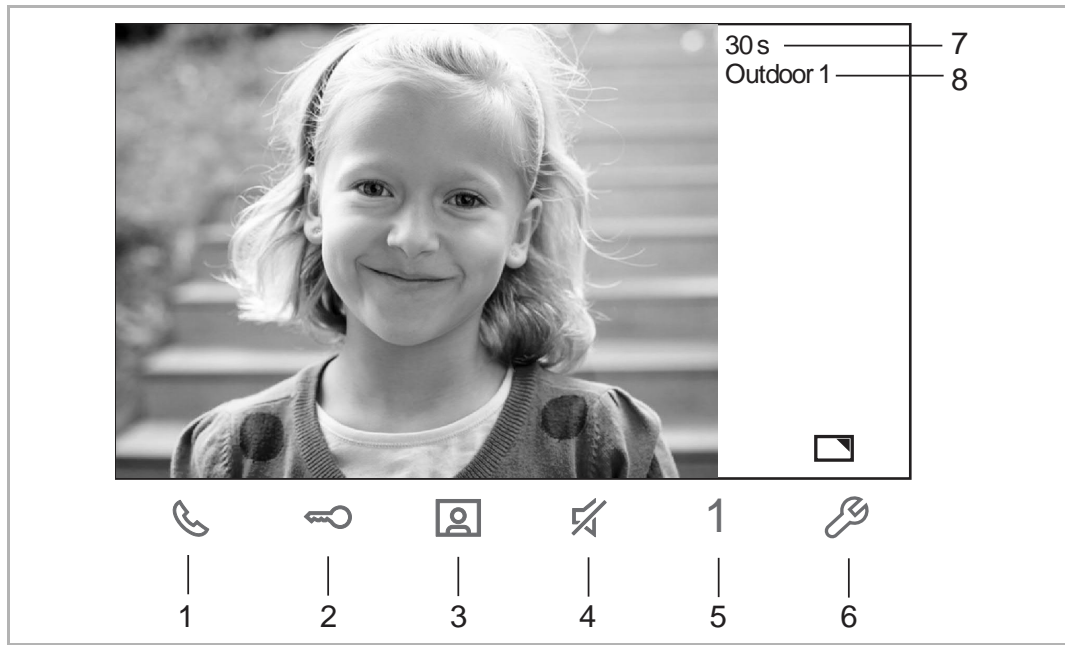

No.	Description
1	During an incoming call, press this button to receive the incoming call. Press this button again during the conversation to end the call.
2	Press this button to release the default lock on the default outdoor station.
3	Press this button to initiate a surveillance. Hold this button to take a snapshot during the surveillance.
4	Press this button to mute the ringtone of an incoming call. Press this button to mute the microphone during the conversation.
5	Press this button to carry out the function assigned to the program button. .
6	Press this button to enable or disable the full-screen function. Hold this button to access the brightness and volume settings.
7	Display the rest time of the conversation.
8	ID of the calling outdoor station

Display and volume settings

During an incoming call, hold "🔑" button for 3 seconds to enter the display settings.

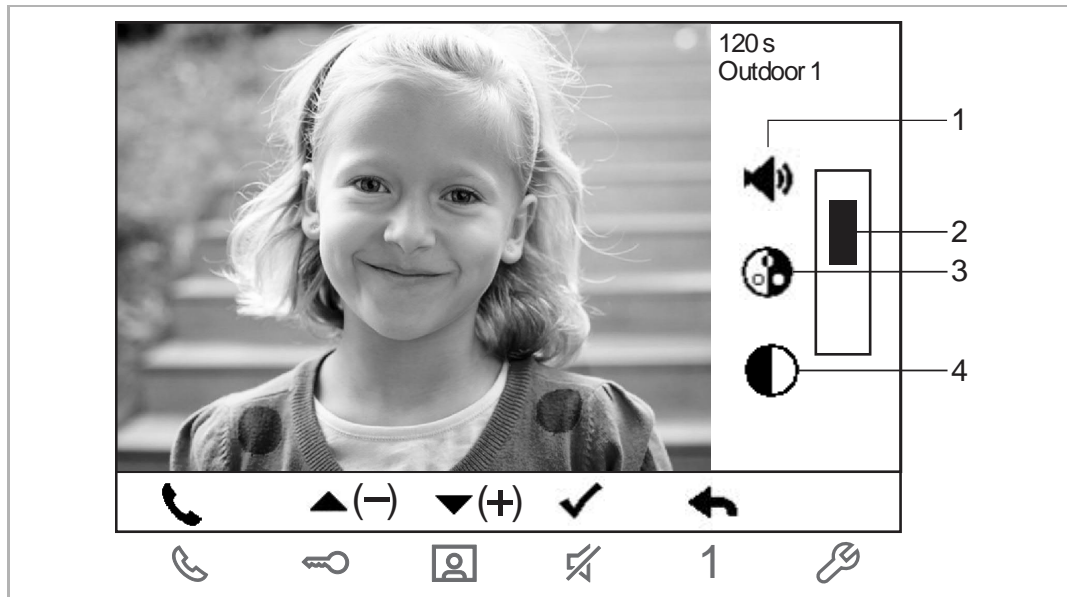

No.	Description
1	In setting status, press "+" or "-" button to adjust the volume.
2	Display the value of volume/saturation/brightness.
3	In setting status, press "+" or "-" button to adjust the saturation.
4	In setting status, press "+" or "-" button to adjust the brightness.

9.2 Intercom

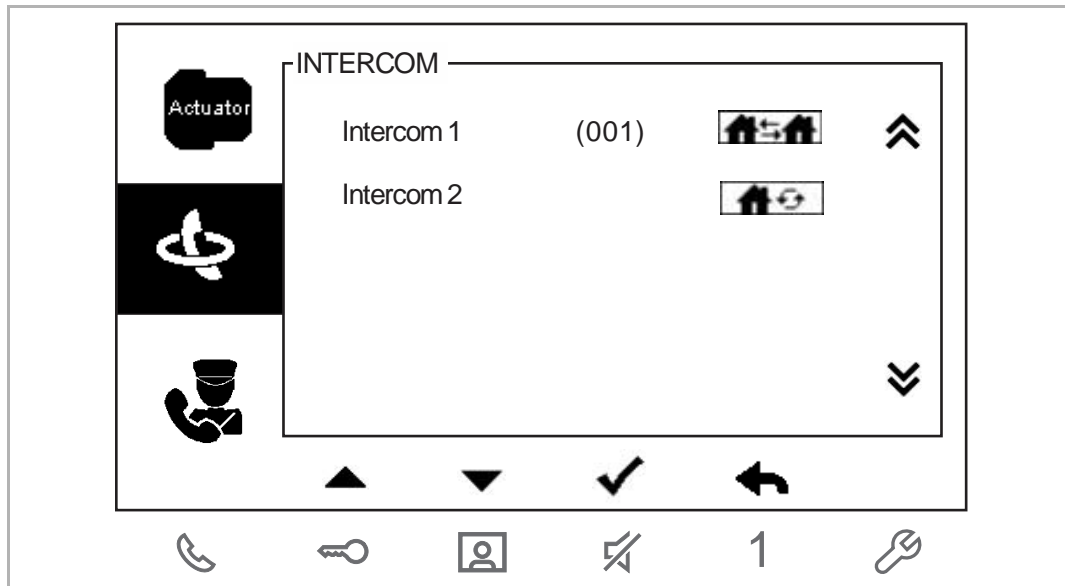

Please follow the steps below:

- [1] In standby status, press "☎" button to access the operation screen.
- [2] Press "▲" or "▼" to select "🔄" on the left list.
- [3] Press "✓" to access the corresponding screen.
- [4] Press "▲" or "▼" to select the designated intercom, then press "✓" to initiate an intercom call.

9.3 Call guard unit

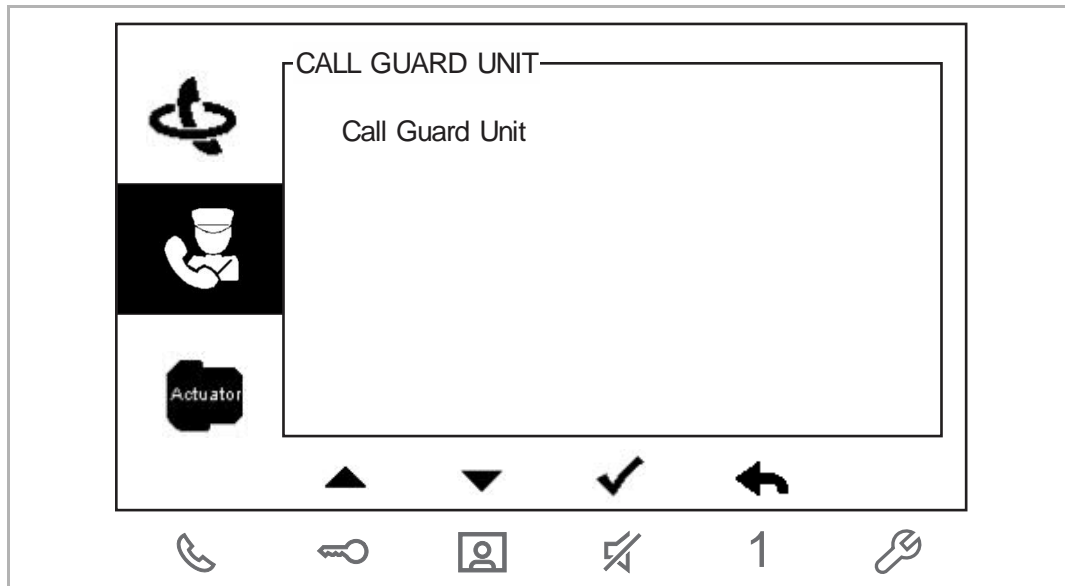

Please follow the steps below:

- [1] In standby status, press "☎" button to access the operation screen.
- [2] Press "▲" or "▼" to select "☺" on the left list.
- [3] Press "✓" to access the corresponding screen.
- [4] Press "✓" to call guard unit.

9.4 Control switch actuator

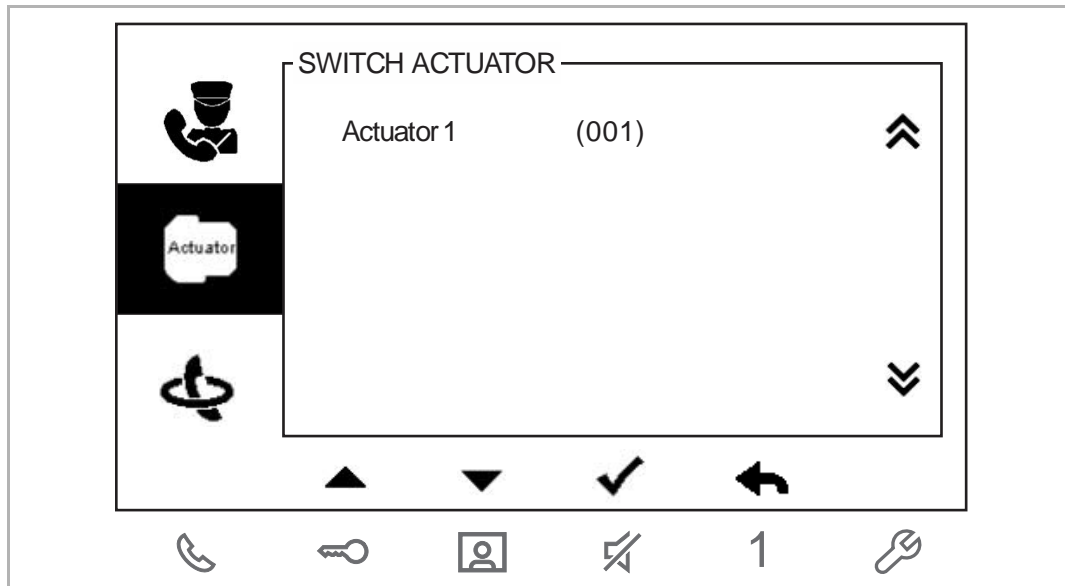

Please follow the steps below:

- [1] In standby status, press "☎" button to access the operation screen.
- [2] Press "▲" or "▼" to select "Actuator" on the left list.
- [3] Press "✓" to access the corresponding screen.
- [4] Press "▲" or "▼" to select the designated switch actuator.
- [5] Press "✓" to release the designated switch actuator.

10 Notice

We reserve the right to at all times make technical changes as well as changes to the contents of this document without prior notice.

The detailed specifications agreed to at the time of ordering apply to all orders. ABB accepts no responsibility for possible errors or incompleteness in this document.

We reserve all rights to this document and the topics and illustrations contained therein. The document and its contents, or excerpts thereof, must not be reproduced, transmitted or reused by third parties without prior written consent by ABB.



ABB Xiamen Smart Technology Co., Ltd.
No.7, Fangshan South Road, Hi-tech area,
Torch park, Xiang An District, Xiamen,
China
Tel: +86 592 295 9000
Fax: +86 592 562 5072

www.abb.com

Copyright © 2020 ABB. All rights reserved.
Specifications subject to change without notice.

sales@rxtx.com.au

+61 45 22 45 222

2TMD041600D0130



www.rxtx.com.au