

RG-AP180

Wi-Fi 6 Dual-Radio Access Point

INNOVATION
Beyond Networks

01

Product Overview

The RG-AP180 is a dual-radio 802.11ax-compliant wall plate wireless access point (AP) provided by Ruijie Networks for general education, higher education, government, finance, business, and other indoor scenarios.

It complies with 802.11ax, 802.11ac Wave 2, 802.11ac Wave 1, and 802.11n. With a hardware-independent dual-radio design, the RG-AP180 can provide a data rate of up to 1.775 Gbps. The ultra-fast wireless rate eliminates the performance bottleneck.

The design of the RG-AP180 considers factors such as

wireless network security, radio control, mobile access, QoS, seamless roaming. With Ruijie's wireless access controller (AC) and Ruijie Cloud, the RG-AP180 can implement wireless client data forwarding, security features, access control.

It can be installed in a Chinese-standard 86 mm x 86 mm junction box. It integrates Ethernet ports. With the sleek and attractive design, the RG-AP180 can be installed in a junction box without any wall damage. It is suitable for wireless network construction in hotels and other environments.

02

Product Appearance



03

Product Highlights

High Speed and Intelligent Network Optimization, Improving User Access Experience

- Support for the latest Wi-Fi standard 802.11ax
- Dual-radio design and a high data rate of up to 1.775 Gbps, providing a seamless and fast experience
- 1 Gbps wired uplink connection with strong performance to support multi-service linkage

- One-click network optimization feature for an even better Wi-Fi experience

Flexible Installation and Simple O&M

- Wall-mounted or mounted in a junction box, greatly saving footprint
- Simple configuration for easy access to high-speed Wi-Fi 6 network

- Supports for cloud unified management and intelligent optimization, making O&M a breeze

04 Product Features

High-speed Wireless Access and Energy Saving

1024-QAM High-speed Access

The RG-AP180 adopts the dual-radio design and complies with Wi-Fi standard IEEE 802.11ax. When dual radios are enabled, it can provide a wireless data rate of up to 1.775 Gbps to realize high-speed access experience.

OFDMA High-density User Access

OFDMA in IEEE 802.11ax enables the RG-AP180 to divide a WLAN channel into multiple narrower sub-channels, with each user occupying one or more sub-channels. The RG-AP180 can schedule services of multiple users, and receive and send packets concurrently. This reduces contention for air interface resources and backoff, shortens the network latency, and improves the network efficiency.

Energy Saving and Lower Power Consumption

The RG-AP180 incorporates the packet-based power control technology. With the high-performance power design, the RG-AP180 is energy-efficient while providing high-speed wireless access service.

Intelligent Recognition

The RG-AP180 can intelligently identify mobile clients such as iOS and Android clients and PCs. It can be used with RG-Cloud to implement visualized wireless network management based on the wireless client type and optimize a network in one-click mode.

Intelligent Local Forwarding

The RG-AP180 integrates intelligent local forwarding technology to eliminate the traffic bottleneck on its connected wireless access controller. The data forwarding mode of the RG-AP180 can be flexibly pre-configured through Ruijie's wireless access controller. Then the RG-AP180 determines whether data needs to be forwarded by the wireless access controller or be sent to a wired network for data exchange based on the SSID or user VLAN.

With the local forwarding technology, the RG-AP180

classifies the data that is sensitive to the delay and requires real-time high-performance transmission, and forwards it through a wired network. This greatly relieves the traffic burden of the wireless access controller and better adapts to heavy-traffic transmission on 802.11ax networks.

Diverse Wi-Fi Technologies

It supports RF transmission technologies:

- Dynamic frequency selection (DFS) optimizes the use of available RF spectrum to prevent radar channel interference.
- Cyclic delay/shift diversity (CDD/CSD) improves downlink RF performance, and converts spatial diversity to frequency diversity to avoid intersymbol interference, thus reducing bit error rate (BER) and effectively reducing signal distortion.
- Maximum ratio combining (MRC) improves the signal quality at the receiving end and enhances reliability and performance of received signals.

It supports RF channel coding technologies:

- Space-time block coding (STBC) increases the range and improves signal receiving, and enhances reliability of data transmission.
- Low-density parity check (LDPC) corrects errors efficiently and improves the throughput.
- Transmit beam-forming (TxBF) expands the signal coverage and enhances the reliability of specific devices, thereby improving the data rate.

Abundant QoS Policies

The RG-AP180 provides abundant QoS policies. It supports bandwidth limiting based on the WLAN, AP, and STA, and provides Wi-Fi Multimedia (WMM) that defines priorities for different service data. Therefore, it implements immediate and quantitative transmission of audio and video data, and guarantees smooth application of multimedia services.

The multicast-to-unicast technology supported by the

RG-AP180 solves the video freezing problem caused by packet loss or long latency in Video on Demand (VoD) and other multicast applications on a wireless network. It enhances the experience in the use of multicast video services on a wireless network.

Comprehensive Security Protection and Ease of Use

User-level Secure Access

The RG-AP180 supports various authentication and encryption technologies, including web authentication, 802.1X authentication, MAC address authentication, and local authentication. It complies with the standard network access control system, and strictly defines network access from the perspective of user access, authorization, host compliance, network behavior monitoring, and network attack prevention. It ensures secure authentication upon network access.

Comprehensive Wireless Security Protection

Through Ruijie Cloud and RG-WS series wireless controller, the RG-AP180 offers many security features, including Wireless Intrusion Detection System (WIDS), RF interference tracking, rogue AP containment, anti-ARP spoofing, and DHCP protection to build a secure and reliable wireless network.

Multiple Easy-to-Use Authentication Modes

Together with Ruijie authentication system or multi-service AC, the RG-AP180 supports a variety of efficient and easy authentication modes such as web, 802.1X, MAC address bypass (MAB), SMS, and QR code-based guest authentication. It conforms to the principle of authentication security upon network access.

MAB authentication frees the client from entering the username and password repeatedly. The username and password are required only upon the first login.

When a guest accesses a wireless network through SMS authentication, an authentication page pops up. On the authentication page, a guest can register an account using the mobile number, and accesses the Internet using the username and password in the SMS received.

QR code-based authentication is easy for guests to access the Internet. After accessing a wireless network, guests can receive a QR code prompt. They can access the network after being authorized by the visited employee, providing better security.

Flexible Device Management Modes

Flexible Switching Between Fat, Fit, and Cloud Modes

The RG-AP180 supports flexible switchover among Fat, Fit, and Cloud deployment modes. In Fit mode, it allows zero-touch provisioning (ZTP) configuration, and comprehensive remote management greatly improves O&M and management efficiency on a wireless network.

Web Management

The RG-AP180 provides the web management GUI of the AP and AC, on which O&M personnel can complete wireless configuration easily and manage the wireless network in an all-round manner. On the AC web GUI, O&M personnel can manage the AP as well as clients connected to the AP, and rate-limit clients and restrict network access behaviors of clients. With the GUI, O&M personnel can plan, manage, and maintain wireless networks conveniently.

Association with the Network Management Software

The RG-AP180 can associate with Ruijie Cloud, which can manage all ACs and APs throughout the network, including device configuration backup and device status query. Ruijie Cloud provides a Wi-Fi heat map to show the wireless signal distribution of APs in real-world situations.

All-in-One for Small Branch Office

In small branch office scenarios, the RG-AP180 serves as an AP to provide the wireless access service for the office area, and also functions as a VPN gateway. This all-in-one design simplifies network deployment and saves building costs.

PPPoE

The RG-AP180 can function as a PPPoE client and connects to the Internet through PPPoE. In this case, no gateway needs to be deployed in a branch office area for Internet access.

NAT

The RG-AP180 supports the Network Address Translation (NAT) function to translate addresses between the LAN in the branch office and the Internet.

IPsec VPN

The RG-AP180 can establish IPsec VPN tunnels between the headquarters and branch offices to implement LAN interconnection.

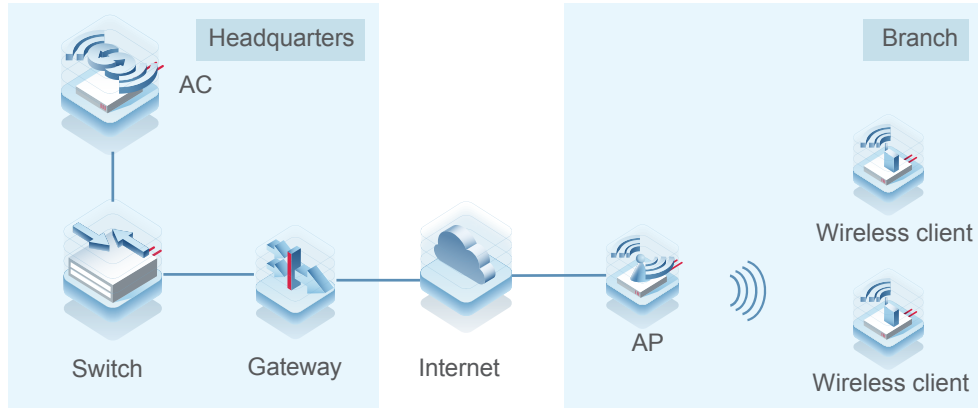

05 Specifications

Hardware Specifications

Dimensions and Weight

| Dimensions and Weight | RG-AP180 |
|---------------------------------|--|
| Unit dimensions (W x H x D) | In-wall: 86 mm x 116 mm x 19 mm (3.4 in x 4.6 in x 0.8 in) Above-wall: 86 mm x 116 mm x 24 mm (3.4 in x 4.6 in x 1.0 in) |
| Shipping dimensions (W x D x H) | 508 mm x 390 mm x 152 mm (20.0 in x 15.4 in x 6.0 in) |
| Unit weight | 0.22 kg (0.49 lbs) |
| Shipping weight | 0.3 kg (0.66 lbs) |
| Mounting | Wall-mount Compatible with 86-mm and EU standard junction boxes (if you want to use the US standard junction box, purchase an RG-AP180-MNT mounting bracket separately) |
| Color | Elegant white |

Wi-Fi Radio

| Wi-Fi Radio | RG-AP180 |
|-----------------------|---|
| Radio design | Dual-radio and up to four spatial streams: <ul style="list-style-type: none"> Radio 1: 2.4 GHz, two spatial streams, 2x2 MU-MIMO Radio 2: 5 GHz, two spatial streams, 2x2 MU-MIMO |
| Operating frequencies | Radio 1: 802.11b/g/n/ax <ul style="list-style-type: none"> 2.400 GHz to 2.4835 GHz, ISM, channels 1 to 13 Radio 2: 802.11a/n/ac/ax <ul style="list-style-type: none"> 5.150 GHz to 5.250 GHz, U-NII-1, channels 36, 40, 44, and 48 5.250 GHz to 5.350 GHz, U-NII-2A, channels 52, 56, 60, and 64 5.470 GHz to 5.725 GHz, U-NII-2C, channels 100, 104, 108, 112, 116, 120, 124, 128, 132, 136, and 140 5.725 GHz to 5.850 GHz, U-NII-3/ISM, channels 149, 153, 157, 161, and 165 Note: Country-specific restrictions apply. |

| Wi-Fi Radio | RG-AP180 |
|---------------------|--|
| Data rates | Radio 1: 2.4 GHz, 574 Mbps <ul style="list-style-type: none"> Two spatial stream Single User (SU) MIMO for up to 574 Mbps wireless data rate to individual 2SS HE40 802.11ax client devices (max.) Two spatial stream Single User (SU) MIMO for up to 287 Mbps wireless data rate to individual 2SS HE20 802.11ax client devices (typical) Radio 2: 5 GHz, 1.2 Gbps <ul style="list-style-type: none"> Two spatial stream Single User (SU) MIMO for up to 1.2 Gbps wireless data rate to individual 2SS HE80 802.11ax client devices (max.) Two spatial stream Single User (SU) MIMO for up to 574 Mbps wireless data rate to individual 2SS HE40 802.11ax client devices (typical) Two spatial stream Multi-User (MU) MIMO for up to 1.2 Gbps wireless data rate to up to two 1SS HE80 802.11ax DL-MU-MIMO capable client devices simultaneously (max.) Two spatial stream Multi-User (MU) MIMO for up to 574 Mbps wireless data rate to up to two 1SS HE40 802.11ax DL-MU-MIMO capable client devices simultaneously (typical) |
| Data rate set | The following 802.11-compliant data rates in Mbps are supported: 2.4 GHz radio <ul style="list-style-type: none"> 802.11b: 1, 2, 5.5, 11 802.11g: 1, 2, 5.5, 6, 9, 11, 12, 18, 24, 36, 48, 54 802.11n: 6.5 to 300 (MCS0 to MCS15, HT20 to HT40) 802.11ac: 6.5 to 400 (MCS0 to MCS9, NSS = 1 to 2, VHT20 to VHT40) 802.11ax: 8.6 to 574 (MCS0 to MCS11, NSS = 1 to 2, HE20 to HE40) 5 GHz radio <ul style="list-style-type: none"> 802.11a: 6, 9, 12, 18, 24, 36, 48, 54 802.11n: 6.5 to 300 (MCS0 to MCS15, HT20 to HT40) 802.11ac: 6.5 to 867 (MCS0 to MCS9, NSS = 1 to 2, VHT20 to VHT80) 802.11ax: 8.6 to 1,200 (MCS0 to MCS11, NSS = 1 to 2, HE20 to HE80) |
| packet aggregation | 802.11n/ac/ax: A-MPDU and A-MSDU |
| Antenna type | Built-in intelligent antenna (two 2.4 GHz antennas and two 5 GHz antennas) |
| Max. antenna gain | 2.4 GHz radio: 2 dBi 5 GHz radio: 2 dBi |
| Max. transmit power | 2.4 GHz radio: 20 dBm (17 dBm per chain) 5 GHz radio: 20 dBm (17 dBm per chain) Note: The transmit power is limited by local regulatory requirements. |
| Power increment | Configurable in increments of 1 dBm |
| Radio technologies | 802.11b: Direct-Sequence Spread-Spectrum (DSSS) 802.11a/g/n/ac: Orthogonal Frequency-Division Multiplexing (OFDM) 802.11ax: Orthogonal Frequency Division Multiple Access (OFDMA) |
| Modulation types | 802.11b: BPSK, QPSK, CCK 802.11a/g/n: BPSK, QPSK, 16-QAM, 64-QAM, 256-QAM 802.11ac: BPSK, QPSK, 16-QAM, 64-QAM, 256-QAM 802.11ax: BPSK, QPSK, 16-QAM, 64-QAM, 256-QAM, 1024-QAM |

The following table lists the radio frequency performance of Wi-Fi including different frequency bands, protocols, and data rates. It is country-specific, and Ruijie Networks reserves the right of interpretation.

| Wi-Fi Radio Frequency Performance | RG-AP180 | | |
|-----------------------------------|-----------|--|--|
| Frequency Band and Protocol | Data Rate | Max. Transmit Power per Transmit Chain | Max. Receive Sensitivity per Receive Chain |
| 2.4 GHz, 802.11b | 1 Mbps | 18 dBm | -91 dBm |
| | 2 Mbps | 17 dBm | -91 dBm |
| | 5.5 Mbps | 16 dBm | -90 dBm |

| Wi-Fi Radio Frequency Performance | RG-AP180 | | |
|-----------------------------------|-----------|--|--|
| Frequency Band and Protocol | Data Rate | Max. Transmit Power per Transmit Chain | Max. Receive Sensitivity per Receive Chain |
| 2.4 GHz, 802.11b | 11 Mbps | 15 dBm | -87 dBm |
| 2.4 GHz, 802.11g | 6 Mbps | 18 dBm | -89 dBm |
| | 24 Mbps | 16 dBm | -82 dBm |
| | 36 Mbps | 16 dBm | -78 dBm |
| | 54 Mbps | 15 dBm | -72 dBm |
| 2.4 GHz, 802.11n (HT20) | MCS0 | 18 dBm | -85 dBm |
| | MCS7 | 15 dBm | -77 dBm |
| 2.4 GHz, 802.11n (HT40) | MCS0 | 18 dBm | -82 dBm |
| | MCS7 | 15 dBm | -64 dBm |
| 2.4 GHz, 802.11ax (HE20) | MCS0 | 18 dBm | -85 dBm |
| | MCS11 | 12 dBm | -58 dBm |
| 2.4 GHz, 802.11ax (HE40) | MCS0 | 18 dBm | -82 dBm |
| | MCS11 | 12 dBm | -54 dBm |
| 5 GHz, 802.11a | 6 Mbps | 18 dBm | -89 dBm |
| | 24 Mbps | 16 dBm | -82 dBm |
| | 36 Mbps | 16 dBm | -78 dBm |
| | 54 Mbps | 15 dBm | -72 dBm |
| 5 GHz, 802.11n (HT20) | MCS0 | 18 dBm | -85 dBm |
| | MCS7 | 15 dBm | -67 dBm |
| 5 GHz, 802.11n (HT40) | MCS0 | 18 dBm | -82 dBm |
| | MCS7 | 15 dBm | -64 dBm |
| 5 GHz, 802.11ac (VHT20) | MCS0 | 18 dBm | -85 dBm |
| | MCS9 | 13 dBm | -60 dBm |
| 5 GHz, 802.11ac (VHT40) | MCS0 | 18 dBm | -82 dBm |
| | MCS9 | 13 dBm | -57 dBm |
| 5 GHz, 802.11ac (VHT80) | MCS0 | 18 dBm | -79 dBm |
| | MCS9 | 13 dBm | -53 dBm |
| 5 GHz, 802.11ax (HE20) | MCS0 | 18 dBm | -85 dBm |
| | MCS11 | 12 dBm | -58 dBm |
| 5 GHz, 802.11ax (HE40) | MCS0 | 18 dBm | -82 dBm |
| | MCS11 | 12 dBm | -54 dBm |
| 5 GHz, 802.11ax (HE80) | MCS0 | 18 dBm | -79 dBm |
| | MCS11 | 12 dBm | -52 dBm |

Bluetooth Radio

| Bluetooth Radio | RG-AP180 |
|---------------------|--|
| Bluetooth | Bluetooth 5.0 |
| Antenna type | Onboard omnidirectional antenna |
| Max. antenna gain | 2.4 dBi, with a downtilt angle of roughly 30 degrees |
| Max. transmit power | 10 dBm |
| Receive sensitivity | -88 dBm (@BLE) |

Ports

| Ports | RG-AP180 |
|-----------------------|--|
| Fixed service port | Uplink: 1 x 10/100/1000Base-T Ethernet port with auto-negotiation, compliant-with IEEE 802.3af/802.3at standard (PoE/PoE+). Downlink: 4 x 10/100/1000Base-T Ethernet ports with auto-negotiation |
| Fixed management port | 1 x Micro USB console port (under the decorative cover) |
| Status LED | 1 x multi-color system status LED |
| Button | 1 x Reset button <ul style="list-style-type: none"> Press the button for shorter than 2 seconds. Then the device restarts. Press the button for longer than 3 seconds. Then the device restores to factory settings. |

Power Supply and Consumption

| Power Supply and Consumption | RG-AP180 |
|------------------------------|--|
| Input power supply | The AP supports the following two power supply modes: <ul style="list-style-type: none"> 12 V DC/1 A power input over DC connector: The DC connector accepts 2.1 mm/5.5 mm center-positive circular plug. A DC power adapter needs to be purchased separately. PoE input over the PoE-in port: The power source equipment (PSE) complies with the IEEE 802.3af standard. The IEEE 802.3at (PoE+) standard is backward compatible with the IEEE 802.3af (PoE) standard. Note: <ul style="list-style-type: none"> When powered by 802.3at (PoE+), the AP operates with the optimal performance. If both DC power and PoE are available, DC power is preferred. |
| External power supply | Not supported |
| Power consumption | Max power consumption: 10 W <ul style="list-style-type: none"> DC powered: 10 W PoE powered (802.3af): 10 W Idle mode: 3.3 W |

Environment and Reliability

| Environment and Reliability | RG-AP180 |
|-----------------------------|--|
| Temperature | Operating temperature: -10°C to +50°C (14°F to 122°F) Storage temperature: -40°C to 70°C (-40°F to +158°F) Note: At an altitude between 3,000 m (9,843 ft) and 5,000 m (16,404 ft), every time the altitude increases by 220 m (722 ft), the maximum temperature decreases by 1°C (1.8°F). |
| Humidity | Operating humidity: 5% to 95% RH (non-condensing) Storage humidity: 5% to 95% RH (non-condensing) |

| Environment and Reliability | RG-AP180 |
|----------------------------------|---|
| IP rating | IP41 |
| Environment standard | Storage and operating environment: NEBS GR-63-CORE_Issue3_2006 GB/T 2423.6-1995 |
| Mean Time Between Failure (MTBF) | 200,000 hours (22 years) at the operating temperature of 25°C (77°F) |

Certifications and Regulatory Compliance

| Certifications and Regulatory Compliance | RG-AP180 |
|--|--|
| Regulatory compliance | GB 4943.1 CE Marked, EN300 328, EN301 893, EN 301 489, EN 50121, EN 50155, EN55032, EN55035 EN 62311, IEC/EN 62368-1(replacing IEC/EN 60950-1) RED Directive 2014/53/EU EMC Directive 2014/30/EU Low Voltage Directive 2014/35/EU |
| Certifications | Wi-Fi Alliance: <ul style="list-style-type: none"> ● 2.4 GHz and 5 GHz Spectrum Capabilities ● Wi-Fi CERTIFIED a, b, g, n, ac, ax (6) ● WPA2™-Enterprise 2018-04 ● WPA2™-Personal 2018-04 ● WPA3™-Personal 2019-08 ● WPA™-Enterprise ● WPA™-Personal ● WMM®, W-Fi Agile Multiband™ |

*For more country-specific regulatory information and approvals, contact your local sales agency.

Software Specifications

| Applicable software version | RG-AP180 |
|-----------------------------|----------|
| Applicable software version | RGOS11 |

WLAN

| WLAN | RG-AP180 |
|--------------------------------|---|
| Max. number of associated STAs | 512 (up to 256 STAs per radio) |
| Max. number of BSSIDs | 16 (up to 8 BSSIDs per radio) |
| STA management | SSID hiding Each SSID can be configured with the authentication mode, encryption mechanism, and VLAN attributes independently. Remote intelligent perception technology (RIPT) Intelligent client identification technology Intelligent load balancing based on the STA quantity or traffic |
| STA limiting | SSID-based STA limiting Radio-based STA limiting |
| Bandwidth limiting | STA/SSID/AP-based rate limiting |
| Wireless roaming | Layer 2 and Layer 3 roaming |

Security and Authentication

| Security and Authentication | RG-AP180 |
|-------------------------------|--|
| Authentication and encryption | Remote Authentication Dial-In User Service (RADIUS) PSK, web, and 802.1X authentication QR code-based guest authentication, SMS authentication, MAB authentication (used with the RG-WS series wireless access controller) Data encryption: WEP (64/128-bit), WPA-TKIP, WPA-PSK, WPA2-AES, WPA3 |
| Data frame filtering | Allowlist, static blocklist, and dynamic blocklist |
| WIDS | WIDS (Wireless Intrusion Detection System) User isolation Rogue AP detection and containment |
| ACL | Dynamic ACL assignment <ul style="list-style-type: none"> • ACL assignment based on time spans • ACL assignment (complete entry) based on MAC addresses • Execution of pre-configured ACLs (entry index) based on MAC addresses |
| CPP | Supported |
| NFPP | Supported |

Routing and Switching

| Routing and Switching | RG-AP180 |
|-----------------------|---|
| IP service | Static IPv4 address and DHCP-assigned IPv4 address NAT ALG FTP and NAT ALG DNS |
| Multicast | Multicast-to-unicast conversion |
| IPv6 basics | IPv6 addressing, Neighbor Discovery (ND), ICMPv6, IPv6 Ping IPv6 DHCP Client |
| IP routing | IPv4/IPv6 static routing |
| VPN | PPPoE client IPsec VPN, up to four IPsec tunnels |

Management

| Management | RG-AP180 |
|-------------------------------|---|
| Network management | NTP server and NTP client SNTP client SNMP v1/v2c/v3 Fault inspection and alarm Information statistics and logging |
| Network management platform | Web-based management (Eweb) |
| STA access management | Console and Telnet-based management TFTP Client |
| Fat/Fit/Cloud mode switchover | When the AP works in Fit mode, it can be switched to Fat mode through an AC. When the AP works in Fat mode, it can be switched to Fit mode through the console port or Telnet. When the AP works in Cloud mode, it can be managed through Ruijie Cloud. |

06

Antenna Pattern Plots

The following figures show the azimuth antenna pattern at 2.4 GHz and 5 GHz radios.

Horizontal Planes (Top View)

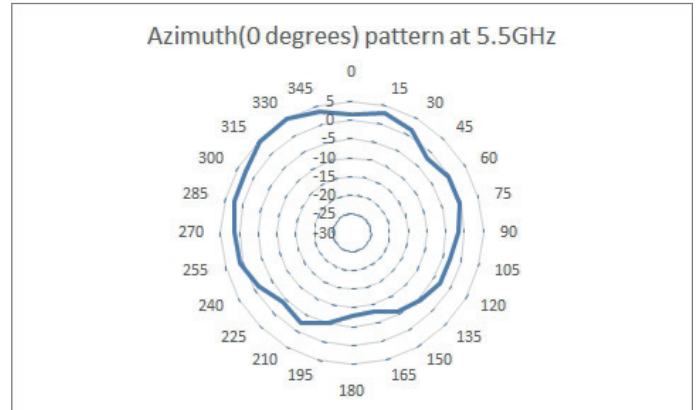
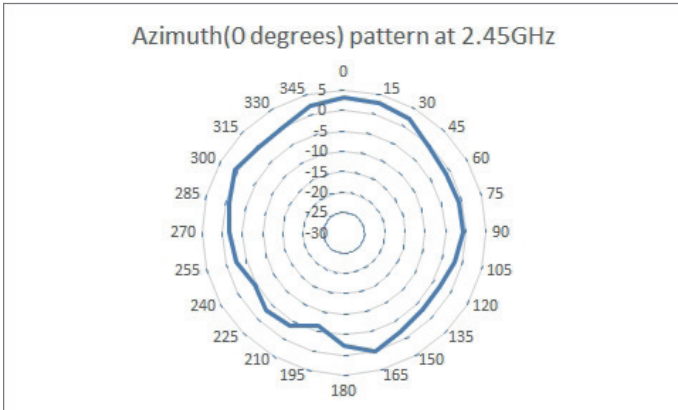

RG-AP180 2.4 GHz (Left) and 5 GHz (Right) Azimuth Antenna Patterns

Vertical Planes (Side View)

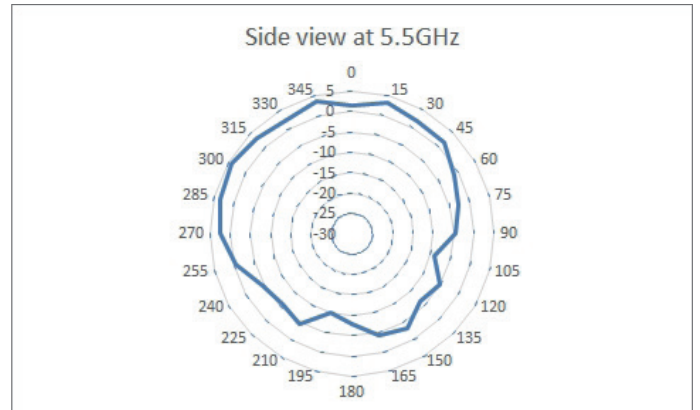
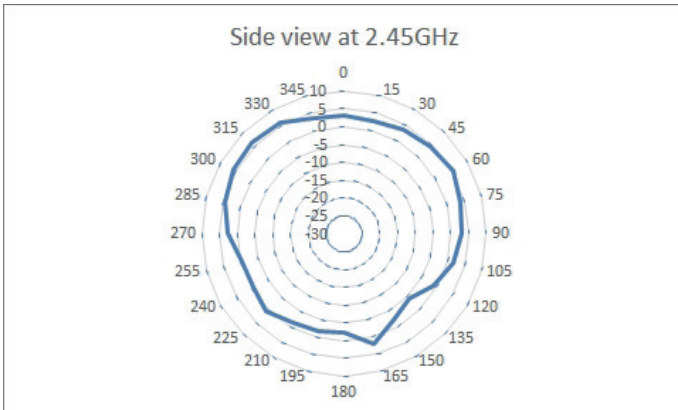

RG-AP180 2.4 GHz (Left) and 5 GHz (Right) Elevation Antenna Patterns

Note: Operating frequency bands are country-specific.

07 Typical Applications

Typical Scenario

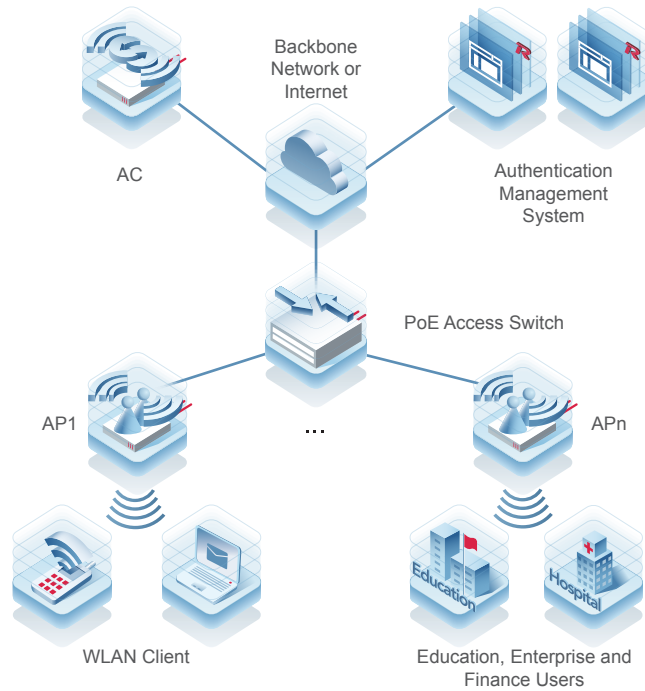

Public Cloud Deployment

With Ruijie public cloud service, the RG-AP180 is fit for SME scenarios, including small offices, boutique hotels, and retail stores. Ruijie Networks provides customers with Ruijie Cloud lifetime free licenses. It significantly streamlines the IT operational efficiency, and simplifies wireless deployment with cost-effective options for SMEs.

The Ruijie Cloud service provides network provisioning, monitoring, optimization, operation, and maintenance. Devices can be easily deployed or swapped in plug-and-play mode. Automatic RF planning meets the needs of increasing user experience.

Cloud Management

- Unified device management
- Flexible group configuration

Mobile Operation

- Seamless provisioning
- Mobile monitoring & alarm notifications

Simplified Security

- PPSK staff authentication
- Hotspot guest Wi-Fi (social login)

Cloud Analytics

- Automated Wi-Fi optimization
- Wi-Fi experience analysis

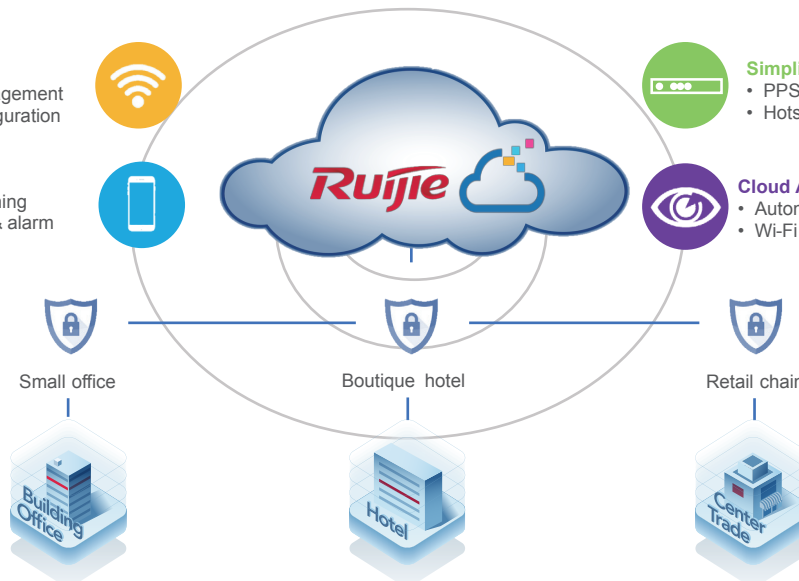

Key Features:

- Unified device management
- Fast provisioning by Cloud and App
- Secure PPSK/UPSK authentication
- Captive portal & social media authentication
- App-based monitoring and alarm

Hybrid Cloud Deployment

For enterprise office, campus network, and hospitality customers with single or multiple sites, a hybrid mode consisting of Ruijie RG-WS series wireless access controller (on-premises) and cloud-based management (optional) is recommended for high-density AP deployment. Wireless access controllers are installed at the customer's site with fully integrated wireless management and authentication features, supporting large-scale AP management with cluster-based controller architecture. Optionally, the cloud management platform allows for value-added features such as centralized device configuration and monitoring, and reporting.

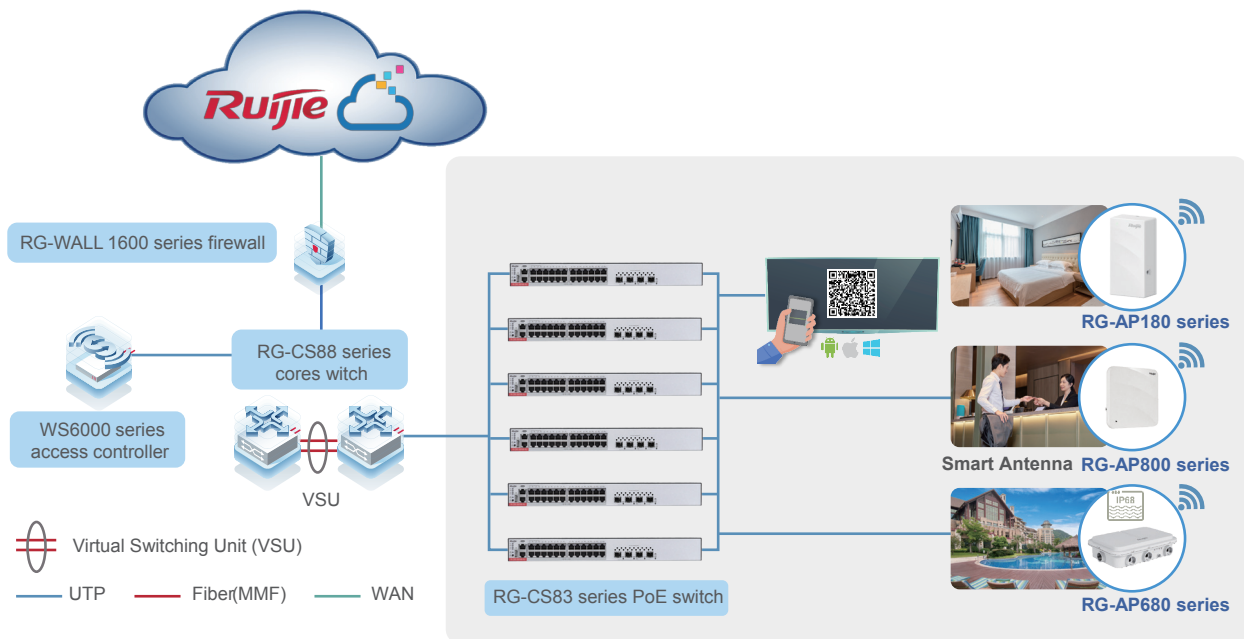

Key Features:

- Centralized device management and reporting by Ruijie Cloud
- Ultra-seamless roaming management
- High performance and security with all user authentication and traffic forwarding handled locally
- Flexible authentication options, including 802.1X, PPSK/UPSK, and voucher authentication
- Unified management of all series of Ruijie APs

08

Ordering Information

| Model | Description |
|--------------|--|
| RG-AP180 | 802.11ax dual-radio wall plate wireless access point Up to four spatial streams Data rate of up to 1.775 Gbps Compliance with IEEE 802.11a/b/g/n/ac and 802.11ax standards Fat/Fit/Cloud mode switchover IEEE 802.3af-compliant power supply and DC power supply Note: <ul style="list-style-type: none"> • A PSE needs to be purchased separately. • A 12 V/1 A power adapter needs to be purchased separately. |
| RG-AP180-MNT | (Optical) Mounting bracket for the US standard junction box. Each set contains 10 pieces. |

09

Package Contents

| Item | Quantity |
|--|----------|
| RG-AP180 (including elegant white cover) | 1 |
| M4 x 40 mm cross recessed pan head screw | 1 |
| Quick Start Guide | 1 |
| Warranty Card | 2 |

10

Warranty

For more information about warranty terms and period, contact your local sales agency:

- Warranty terms: <https://www.ruijienetworks.com/support/servicepolicy>
- Warranty period: <https://www.ruijienetworks.com/support/servicepolicy/Service-Support-Summary>

Note: The warranty terms are subject to the terms of different countries and distributors.

11

More Information

For more information about Ruijie Networks, visit the official Ruijie website or contact your local sales agency:

- Ruijie Networks official website: <https://www.ruijienetworks.com/>
- Online support: <https://www.ruijienetworks.com/support>
- Hotline support: <https://www.ruijienetworks.com/support/hotline>
- Email support: service_rj@ruijienetworks.com

The Ruijie logo is displayed in a bold, red, italicized sans-serif font. It is centered within a large, light blue, semi-transparent graphic that resembles a stylized 'R' or a rounded square with a diagonal cut. The background of the page features abstract, overlapping light blue and white shapes with soft gradients and thin red lines.

Copyright ©2000-2023 Ruijie Networks Co., Ltd. All rights reserved.

No part of this document may be reproduced or transmitted in any form or any means without prior written consent of Ruijie Networks Co., Ltd.

Notice

This content is applicable only to regions outside the China mainland. Ruijie Networks Co., Ltd. reserves the right to interpret this content.

The information contained herein is subject to change without notice. Nothing herein should be construed as constituting an additional warranty. Ruijie Networks Co., Ltd. shall not be liable for technical or editorial errors or omissions contained herein.



Ruijie Networks Co., Ltd
Floor 11, East Wing, Zhongyipengao Plaza,
No.29 Fuxing Road, Haidian District, Beijing China
Website: <https://www.ruijienetworks.com>

