

DS-KD8003Y-IME2 Two wire main unit



The KD8 series 2-wire modular door station helps to provide a safety environment with high resolution image by high resolution camera. According to different scenarios, you can choose different sub modules to extend the device functions, such as display module, signing module, button module, card presenting module, etc., which is suitable for intercom and access control requirements. You can also choose different Hikvision's brackets, with simple appearance and great texture, satisfying different installation methods, such surface mounting, flush mounting, etc. The device can also power up to 2 door locks directly, which is safe and easy for installation and deployment. It is suitable for the scenarios of apartment, office, construction site, etc.

- 2-Wire main unit of modular door station
- 2 MP fisheye camera with IR supplement
- One call Physical Button For easier calls
- Two-lock control
- IP65 protection level
- Convenient configuration via Web remotely
- Directly provide 12 V, 500 mA power output for one electronic lock without additional power supply

▪ Specification

System parameters	
Operation system	Embedded Linux operation system
ROM	32 MB
RAM	256 MB
Processor	Embedded Processor
Display parameters	
Screen size	/
Operation method	/
Type	/
Resolution	/
Video parameters	
Lens	1
Resolution	2 MP
FOV	Horizontal: 146°, Vertical: 82°
Wide dynamic range (WDR)	Support
Supplement light	IR light, up to 3 m
Video compression standard	H.264
Audio parameters	
Audio input	1 built-in omnidirectional microphone
Audio compression standard	G.711 U, G.711 A
Audio output	1 built-in loudspeaker
Audio compression bitrate	64 Kbps
Audio quality	Noise suppression and echo cancellation
Volume adjustment	Adjustable
Capacity	
User capacity	2000
Face capacity	NA
Fingerprint capacity	/
Message capacity	/
Linked indoor station capacity	500
Sub door station capacity	16
Network parameters	
Network protocol	NA
Wi-Fi	/
Bluetooth	/
3G/4G	/
Device interfaces	
Alarm input	4 (2 exit buttons and 2 door contacts by default)
Network interface	NA
TAMPER	1
Exit button	2 (2 for lock control)
RS-485	1 (1 for Hikvision's sub module communication)
USB	NA
Wiegand	NA
TF card	NA

Alarm output	NA
Lock control	2 relays, Max. to 30 VDC, 2 A
Door contact input	2
Two-Wire IP interface	1
General	
Button	1
Installation	Surface mounting, flush mounting
Indicator	/
Weight	Net weight: 0.380 kg Gross weight: 0.541 kg
Protective level	IP65
Working temperature	-40° C to 60° C (-22° F to 140° F)
Working humidity	10% to 90%
Dimension (W × H × D)	100 mm × 98 mm × 42 mm
Battery	/
Power supply	Powered by KAD704Y or KAD706Y series distributor
Application environment	Outdoor
Power consumption	≤ 4 W
Language	English, French, Portuguese, Brazilian Portuguese, Spanish, Russian, German, Italian, Polish, Turkish, Vietnamese, Arabic, Czech, Hungarian, Dutch, Romanian, Bulgarian, Ukrainian, Croatian, Serbian, Greek, Slovak

▪ Available Model





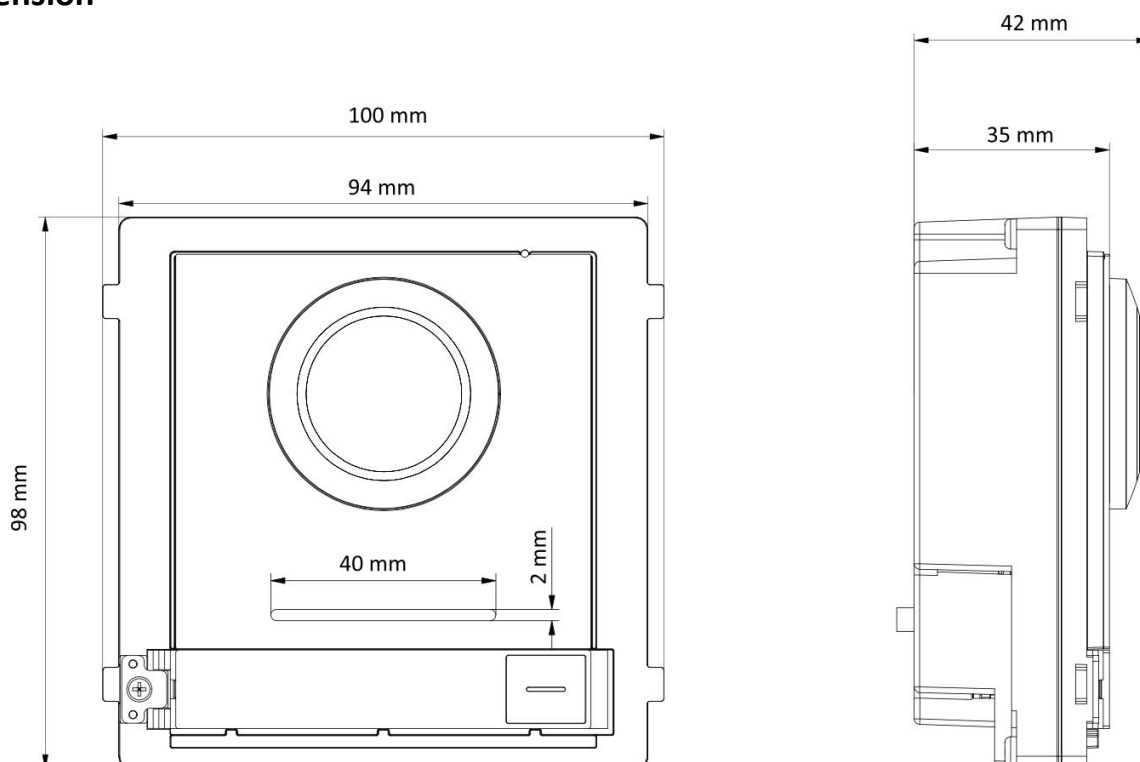





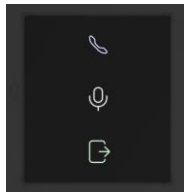
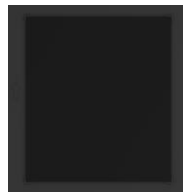

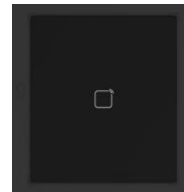
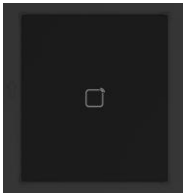



DS-KD8003Y-IME2





▪ Dimension



▪ **Accessory**

▪ **Optional**

<p>DS-KD-KK KD8 Series Pro Modular Door Station</p> 	<p>DS-KD-IN KD8 Series Pro Modular Door Station</p> 	<p>DS-KD-BK KD8 Series Pro Modular Door Station</p> 	<p>DS-KD-KP KD8 Series Pro Modular Door Station</p> 	<p>DS-KD-M KD8 Series Pro Modular Door Station</p> 
<p>DS-KD-E KD8 Series Pro Modular Door Station</p> 	<p>DS-KD-DIS KD8 Series Pro Modular Door Station</p> 	<p>DS-KD-ACW1 2nd Video Intercom Brackets</p> 	<p>DS-KD-ACW2 2nd Video Intercom Brackets</p> 	<p>DS-KD-ACW3 2nd Video Intercom Brackets</p> 
<p>DS-KD-INFO KD8 Series Pro Modular Door Station</p> 	<p>DS-KABD8003-RS1 Rain Shield of Module Door Station</p> 	<p>DS-KABD8003-RS2 Rain Shield of Module Door Station</p> 	<p>DS-KABD8003-RS3 Rain Shield of Module Door Station</p> 	<p>DS-KD-ACF1/Plastic 2nd Video Intercom Brackets</p> 
<p>DS-KD-ACF2/Plastic 2nd Video Intercom Brackets</p> 	<p>DS-KD-ACF3/Plastic 2nd Video Intercom Brackets</p> 	<p>DS-KD-TDM</p> 	<p>DS-KD-TDE</p> 	<p>DS-KIS702Y-P</p> 

DS-KAD706Y-P	DS-KD-KP#EU	DS-KD-ACW1#EU	DS-KD-ACW2#EU	DS-KD-ACW3#EU
				

Headquarters

No.555 Qianmo Road, Binjiang District,
Hangzhou 310051, China
T +86-571-8807-5998
www.hikvision.com



Follow us on social media to get the latest product and solution information.

