

Outdoor Full-Color Bullet Network Camera

MODEL: VIGI C385 (2.8mm/4mm)



4K **H.265+**
VIGI C385

Human & Vehicle
Classification

Smart Detection

Active Defense

True WDR

Two-Way Audio

// Human & Vehicle Classification

Intelligently distinguishes humans and vehicles from other objects, so you receive more accurate event notifications.



// Smart Detection

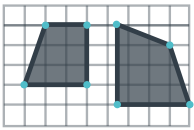

Intrusion Detection

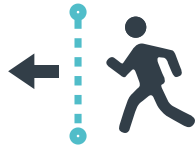

Line-Crossing Detection



Object Removal Detection



Abandoned Object Detection



Region Entering Detection



Region Exiting Detection

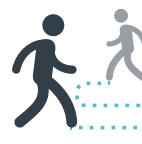

Loitering Detection

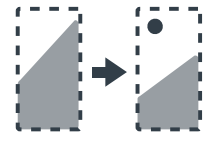

Scene Change Detection

// VIGI Surveillance Solution

The VIGI professional surveillance system by TP-Link is dedicated to protecting the business that you've worked hard to build—whenever, wherever.

Outstanding functions, reliable quality guarantees, and simplified installation work together to ensure your business stays safe and sound.

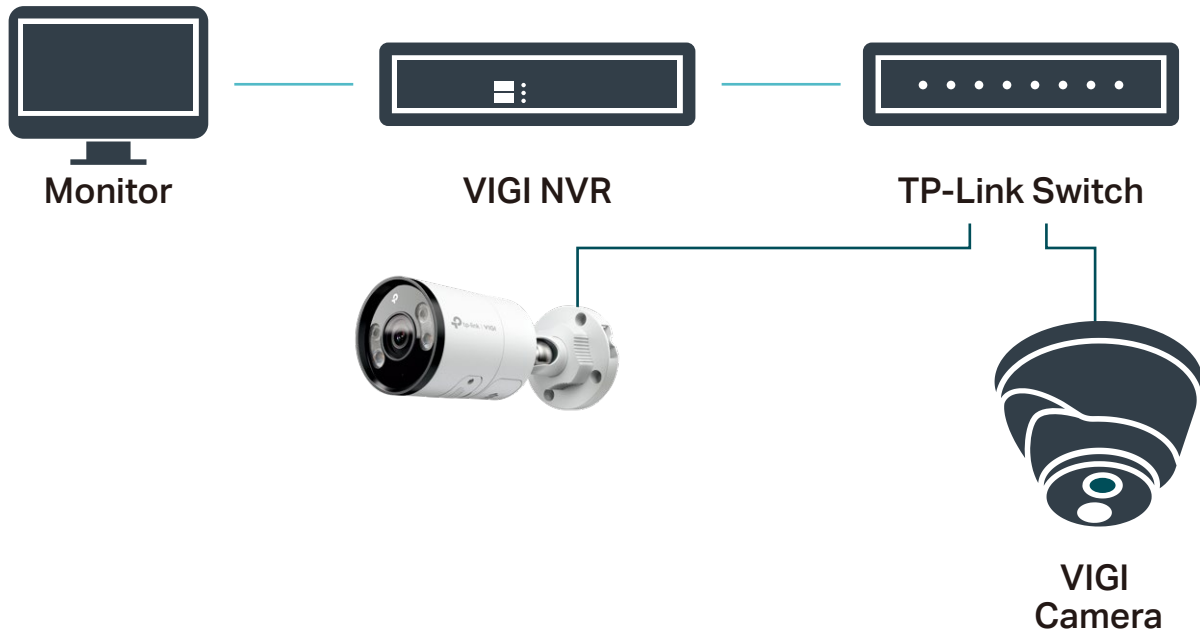

// Flexible Installation

Find the perfect vantage point by simply securing your camera to the ceiling, wall, or pole*.

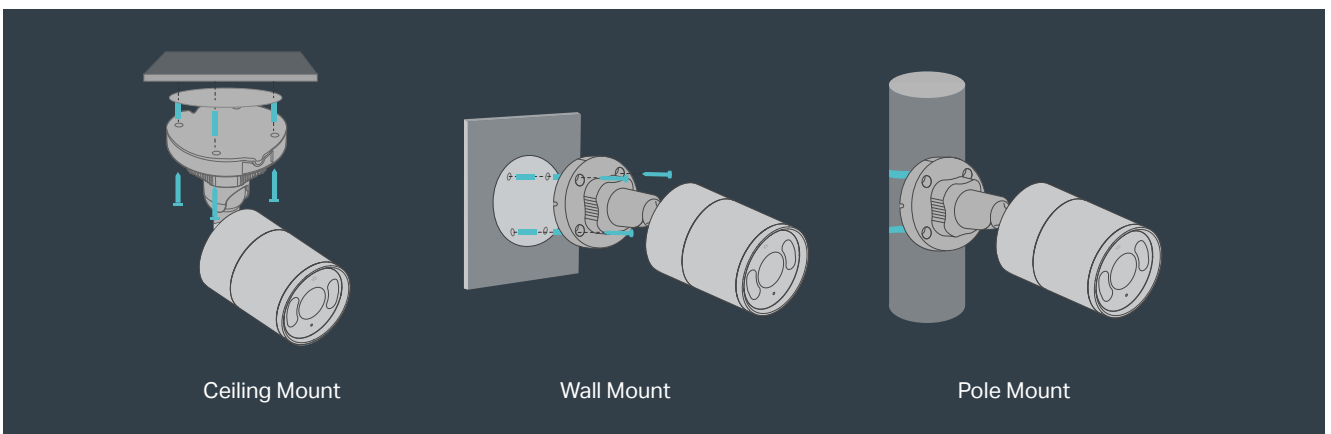

Specifications

Camera	
Product Model	VIGI C385(2.8mm/4mm)
Image Sensor	1/2.7" Progressive Scan CMOS
Min. Illumination	0.005 Lux; 0 Lux with IR/White Light
Shutter Speed	1/3 to 1/10000 s
Slow Shutter	Yes
Day & Night Mechanism	IR Cut Filter
Day/Night Switch	Unified/Scheduled/Auto
Lens	
Type	Fixed Focal Lens
Focal Length	4 mm 2.8mm
Aperture	F1.6
FOV	4mm: Horizontal FOV:91.5°, Vertical FOV: 46.1°, Diagonal FOV: 109.6° 2.8mm: Horizontal FOV:111.4°, Vertical FOV: 58.8°, Diagonal FOV: 134°
Lens Mount	M12
DORI Distance	<ul style="list-style-type: none"> • 4 mm: Detect: 107 m (350 ft) Observe: 44 m (146 ft) Recognize: 21 m (70 ft) Identify: 11 m (35 ft) • 2.8 mm: Detect: 85 m (278 ft) Observe: 35 m (116 ft) Recognize: 17 m (56 ft) Identify: 8 m (28 ft)
Illuminator	
IR LED	Quantity: 2 Range: 30m Wavelength: 850nm
White LED	Quantity: 2 Range: 30m
Illuminator On/Off Control	Auto/Scheduled/Always on/Always off
Video	
Max. Resolution	3840x2160

Main Stream	<p>Frame Rate 50Hz: 1fps, 5fps, 10fps, 15fps, 20fps, 25fps 60Hz: 1fps, 5fps, 10fps, 15fps, 20fps, 25fps</p> <p>Resolution: 3840x2160, 2560x1440, 2304x1296, 2048x1280, 1920x1080, 1280x720</p> <p>Note: If the image rotation is set to 90° or 270°, the frame rate only supports up to 20fps. If HDR is turned on, the frame rate can only support up to 20fps.</p>
Sub-Stream	<p>Frame Rate 50Hz: 1fps, 5fps, 10fps, 15fps, 20fps, 25fps 60Hz: 1fps, 5fps, 10fps, 15fps, 20fps, 25fps</p> <p>Resolution: 704x576, 640x480, 352x288, 320x240</p> <p>Note: If the image rotation is set to 90° or 270°, the frame rate only supports up to 20fps. If HDR is turned on, the frame rate can only support up to 20fps.</p>
Bit Rate Control	CBR, VBR
Video Compression	Main stream: H.265/H.265+/H.264/H.264+ Sub-stream: H.265/H.264
Video Bit Rate	Main Stream: 256 Kbps to 6 Mbps Sub-Stream: 64 Kbps to 512 Kbps
Image	
Image Settings	Mirror, Brightness, Contrast, Saturation, Sharpness, Exposure, WDR, White Balance, HLC Adjustable by Client Software
Day/Night Switch	Unified, Scheduled, Auto
Image Enhancement	BLC, HLC, 3D DNR
Wide Dynamic Range (WDR)	120dB
SNR	≥ 52 dB
Image Parameters Switch	Yes
Privacy Mask	Up to 4 Masks
ROI	1 Region
OSD Setting	Yes
Audio	
Audio Communication	Two-way audio
Audio Input	Yes
Audio Output	Yes
Audio Compression	Yes
Audio Sampling Rate	8KHz
Environment Noise Filtering	Yes
Audio Bit Rate	64 Kbps(G.711 alaw)
Network	
Protocols	TCP/IP, UDP, ICMP, HTTP, HTTPS, DHCP, DNS, RTSP, NTP, UPnP, UDP, SSL/TLS

API	Open Network Video Interface (Profile S)
Web Browser	Google Chrome® 57 and above Firefox® 52 and above Safari® 11 and above Microsoft® Edge 91 and above
Security	Password Protection, HTTPS Encryption, IP Address Filter, Digest Authentication
Simultaneous Live View	3 Main Streams & 3 Sub-Streams
Client	VIGI App, VIGI Security Manager, VIGI NVR, Web,VMS
Cloud	Yes
ONVIF	Yes
Interface	
Network Interface	1 RJ45 10/100M Self-Adaptive Ethernet Port, PoE
On-board Storage	Built-In Memory Card Slot, Support MicroSD Card, Up to 256 GB
Built-in Speaker	Yes
Built-in Microphone	Yes; Records Anything Going on within a 15-ft Radius of the Camera
Audio	N/A
Alarm	N/A
Reset Button	Yes
Power	DC Power Port
Alarm and Event Management	
Smart Event	<ul style="list-style-type: none"> • Human & Vehicle Classification • Intrusion Detection • Line-Crossing Detection • Region Entering Detection • Region Exiting Detection • Object Abandoned Detection • Object Removal Detection • Loitering Detection • Smart Frame • People Detection • Vehicle Detection
Basic Event	<ul style="list-style-type: none"> • Motion Detection • Video Tampering Detection • Exception (Illegal Login) • Scene Change Detection
Alarm Linkage	<ul style="list-style-type: none"> • Memory Card Video Recording • Message Push • Audible Warning • White Light Flashing
Linkage Method	N/A
Output Notification	Message Push
General	
Operating Temperature	-30–60 °C
Storage Temperature	-40–60 °C

Operating Humidity	95% or Less (Non-condensing)
Storage Humidity	95% or Less (Non-condensing)
Power Supply	12V DC±5%, Max. 10.5W, 5.5mm Coaxial Power Plug PoE: 802.3af/at, class 0, Max. 11.5 W
Material	Metal
Protection	IP67
Product Dimensions (L x W x H)	74*74*184mm
Package Contents	VIGI Network Camera Quick Start Guide Waterproof Cable Attachments Mounting Accessories
Net Weight	0.525 Kg
Certifications	CE, NTRA, VCCI, KC, BSMI, FCC, IC

Dimensions

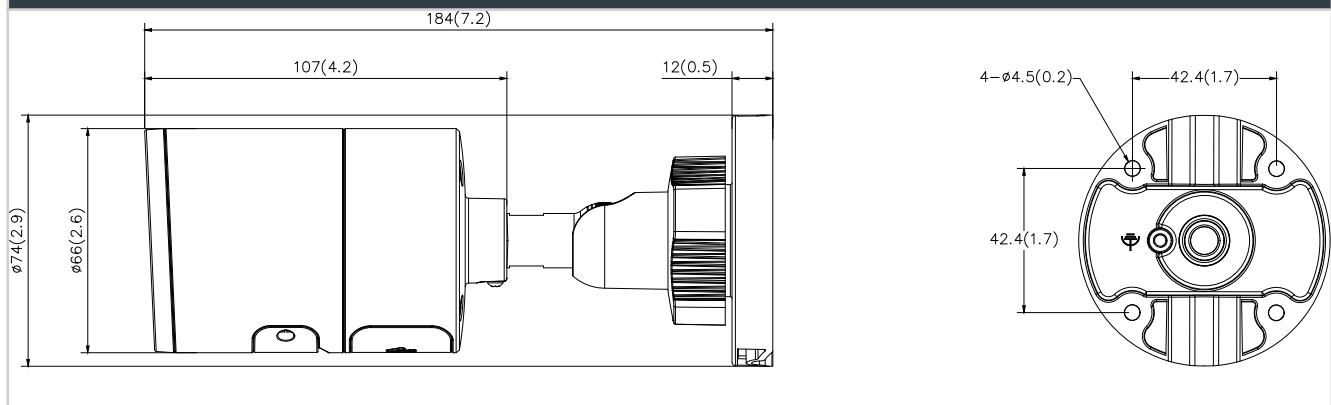

*Pole mounting kits and SD card are not included in the package.

Specifications are subject to change without notice and can be found at www.tp-link.com.

©2023 TP-Link